



# XL Detect / XL Detect +<sup>TM</sup> VideoProbe<sup>®</sup>

Operating Manual



# Table of Contents

1	Introduction.....	7
	Controls .....	8
	Indicators and Connectors .....	10
2	Safety Information .....	12
	General Warnings .....	12
	Battery Warnings.....	13
3	Setup .....	16
	System Removal .....	16
	System Power On .....	16
	System Power Off .....	17
	System Storage.....	17
	Mounting Accessories .....	18
	Battery .....	19
	Charging Battery .....	20
	Keyboard Support .....	21
	Saving Images and Video .....	22
	Optical Tips.....	22
	Optical Tip Installation .....	23
4	Operation.....	24
	GO TO Menu.....	24
	GO TO > Light Output .....	26
	GO TO > Long Exposure.....	27
	Live Main Menu .....	30
	Live Main Menu > Light Output .....	30
	Live Main Menu > Image Control .....	31
	Live Main Menu > Annotation .....	35
	Live Main Menu > File Manager.....	40
	Live Main Menu > Eject Hardware .....	41
	Live Main Menu > Setup .....	42
5	Inspecting .....	61
	Capturing Images and Video .....	61
	Articulation Lock .....	61
	Freeze Frame .....	63
	File Manager .....	65
	Video Playback Menu.....	72
	Menu Directed Inspection (MDI).....	73
6	Maintenance.....	74
	Inspecting and Cleaning the System.....	74
	Cleaning Optical Tips .....	74

7 Service .....75

8 Technical Specifications .....76

Appendix .....80

A- Optical Tip Table .....80

B. Chemical Compatibility .....82

C. Warranty .....82

D. Creating a Personalized Logo File.....83

9 Environmental Compliance .....84

EU Battery Directive .....84

Agency Certifications.....84

China RoHS .....86

FCC Compliance .....87

Canadian Notice.....87

10 Disassembly and Disposal .....88

This instruction handbook is for use by the owner of the Remote Visual Inspection equipment and their personnel. Waygate Technologies remains the owner of the copyright on this instruction handbook. No part of this work covered by the copyrights herein may be translated, reproduced, stored in information retrieval systems, or transmitted, in any form or by any means - graphic, electronic, or mechanical, including photocopying, recording, taping, or otherwise - without the prior written permission of the publishers. Individual reproductions are allowed for business purposes only with the prior written consent of Waygate Technologies.

Should you have any questions concerning clarification of problems in connection with application, use, operation, specification of your Remote Visual Inspection equipment, please contact the following:

#### Technical Support Contact Information

Global Phone: 1-866-243-2638

Tech Support Option: 4#

Help as easy as 1- 2- 3 - 4:

- 1 - Ultrasonic / Eddy Current
- 2 - Radiography
- 3 - Remote Visual Inspection
- 4 - Rhythm Software
- 5 - PMI (Positive Material Identification)

Email: RemoteSupport@GE.com

Contact information is subject to change. Please visit the Waygate Technologies website for the latest contact information.

**NOTE:** The terms XL Detect and XL Detect+ within this document are used interchangeably and with the intent that both are applicable unless otherwise specified.

**This equipment is manufactured under one or more of the following US patents:**

- 4,980,769
- 6,468,201
- 6,590,470
- 6,959,432
- 7,170,677
- 7,262,797
- 7,564,626



# 1 Introduction

## About this Manual

This manual and the related equipment is intended for visual inspection technicians with a basic understanding of inspection principles and practices, and who are familiar with basic computer operations, but who may not have experience with a video borescope system.

The manual contains complete setup, operating, and maintenance instructions for the XL Detect and XL Detect+ video borescope system. The manual also provides a product overview, step-by-step procedures, and reference information.

To ensure operator safety, please read and understand this manual prior to using the system.

## Standard Kit Components

- XL Detect
- XL Detect Storage Case
- Optical Tip Storage Case
- Documentation USB Thumbdrive
- Quickstart Card
- 2-hour Li-Ion Battery
- AC Adapter/Battery Charger

## Optional Accessories

Headset	Neck Strap
VGA Video Cable	Spare USB Thumbdrive
IT Gripper	Belt Clip
IT Rigidizer	Sun Visor
Mini-Magic Arm	Mounting Kit
Car Cord	Handset Mounting Hook
Handset Holder	Keyboard
Soft Case	Spare 4 hour battery

# Controls

The following buttons control basic and advanced operation of the XL Detect VideoProbe

## 1 Left Soft Key -

Activates screen command listed on system LCD. This key will most frequently return the user BACK one screen.



## 2 Power/Exit -

Turns system power on/off. Also used to exit menus, return to live/frozen video and disable image control features.

## 3 Joystick

Controls articulation. Press to activate the Live Main Menu, Recalled Image Menu, and Freeze Frame Menu. Push the joystick left/right/up/ down to navigate menus and sub-menus.

## 4 Steering Control -

Press and release to keep bending neck locked in place after the joystick is released. A  lock will appear on the LCD when enabled. Press and release again to unlock the steering control. The  lock will disappear from LCD when disabled. Also, press and hold to engage HOME function to straighten bending neck. A blinking  Home icon will appear on the LCD when enabled. This icon will disappear when finished.

## 5 Freeze/Enter -

Freezes the image on-screen. Also acts as enter key for selecting options.

## 6 Right Soft Key -

Activates screen command listed on system LCD. This key will most frequently serve to SELECT active menu choices.

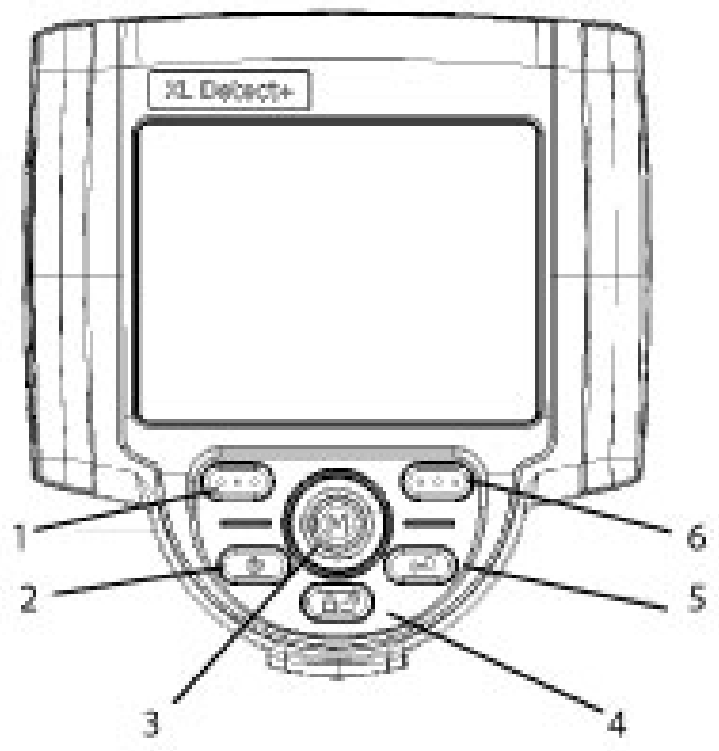
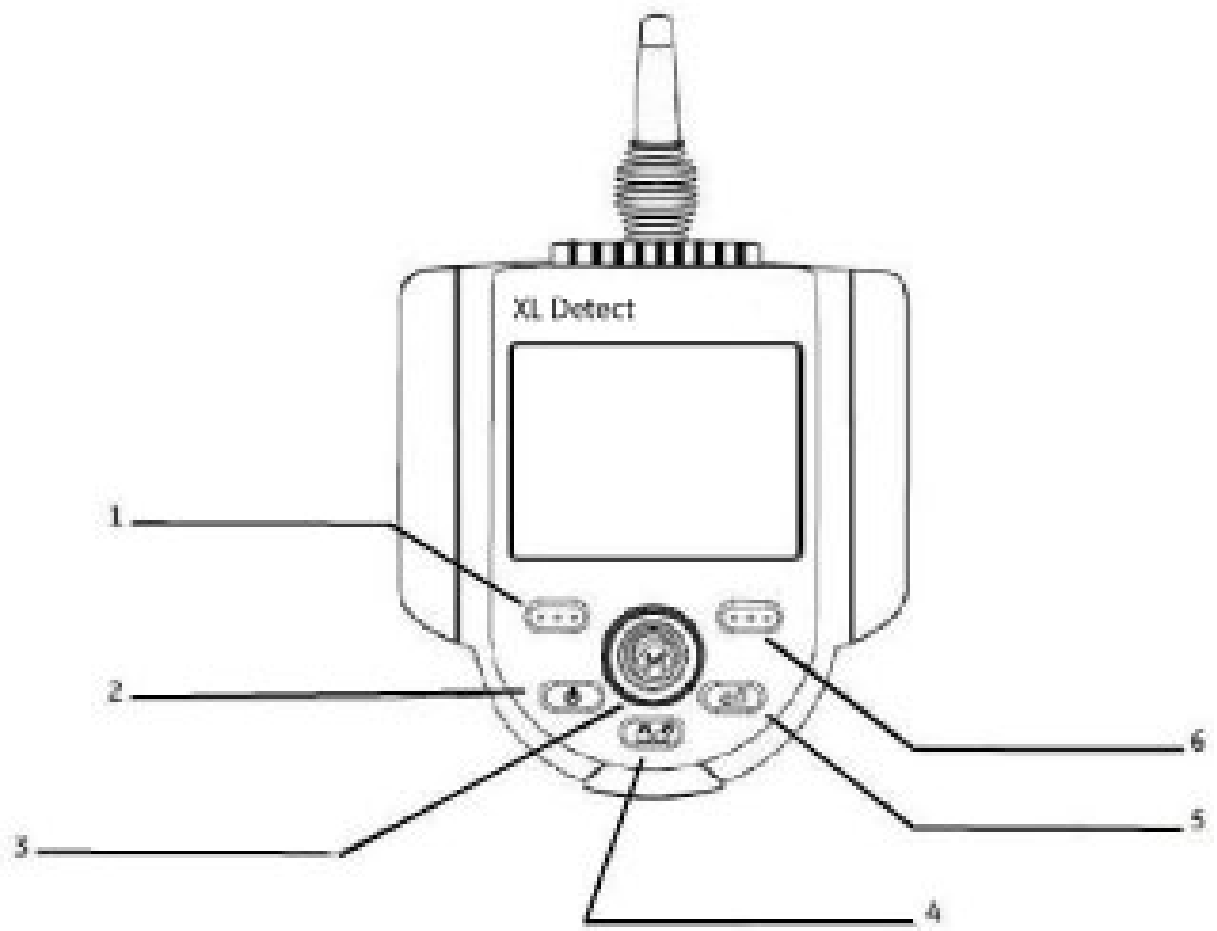

## Indicators and Connectors

1. LCD Screen
2. Integrated 2.5 mm headset/microphone jack
3. VGA output
4. Controls
5. 2-hour Lithium Ion Battery
6. Battery Charge Indicator
7. AC to DC Adaptor Input
8. USB Bay

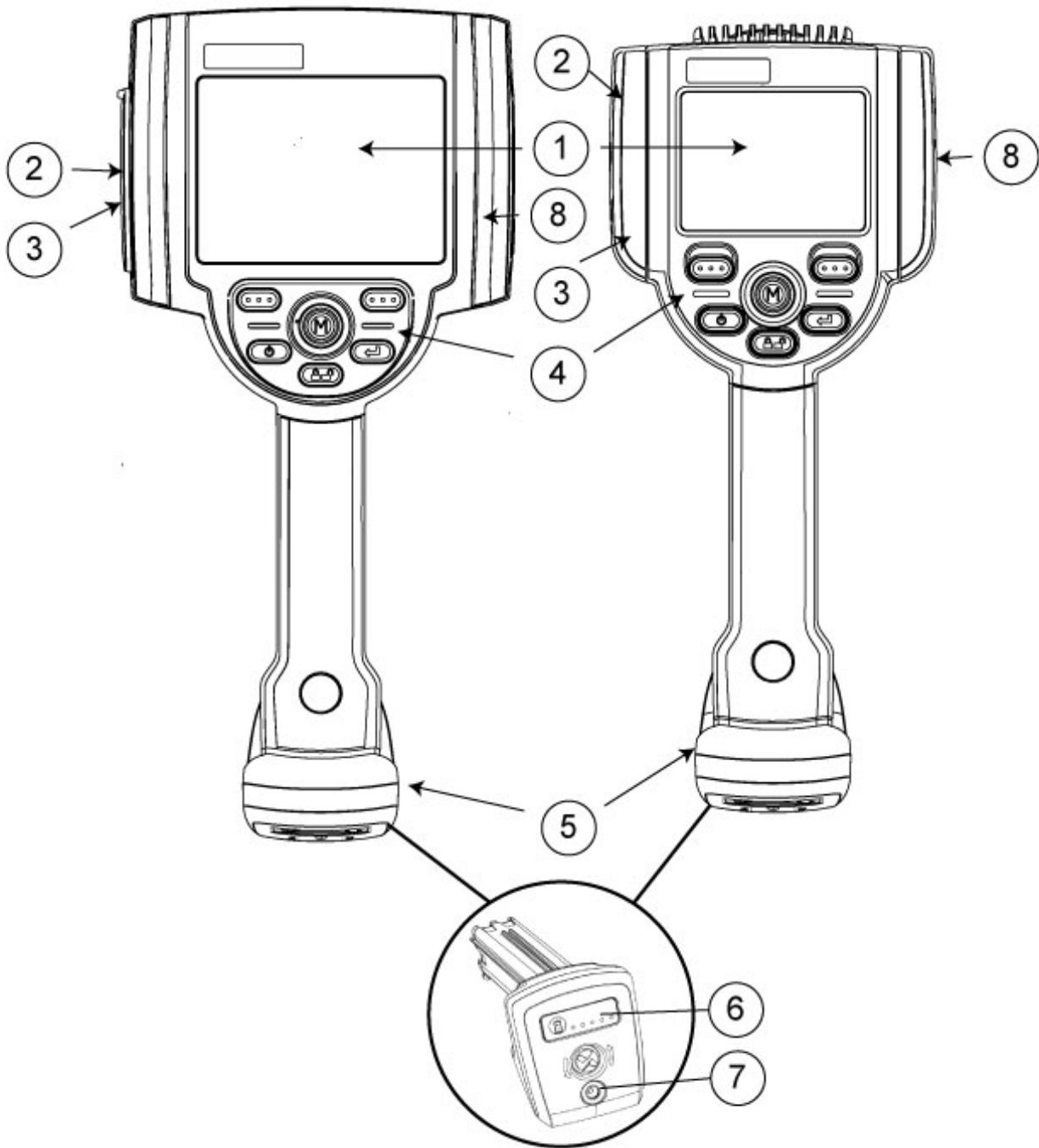

## 2 Safety Information

**Note:** Before using or servicing the system, read and understand the following safety information.

### Symbols and Terms

The following symbols appear on the product:

 See accompanying documentation.

### General Warnings

The following warning statements apply to use of the system in general.

Warning statements that apply specifically to particular procedures appear in the corresponding sections of the manual.

 Do not allow the conductive insertion tube, system or its working tools to come in direct contact with any voltage or current source. Prevent all contact with live electrical conductors or terminals. Damage to the equipment and/or electrical shock to the operator may result.

 Do not use this system in explosive environments

 **USE PROPERLY.** Using any piece of this equipment in a manner not specified by the manufacturer may impair the product's ability to protect the user from harm.

 XL Detect power supply is rated for indoor use only.

### General Cautions

The following caution statements apply to use of the XL Detect device in general. Caution statements that apply specifically to particular procedures appear in the corresponding sections of the manual.

**HANDLE PROBE CAREFULLY.** Keep the insertion tube away from sharp objects that might penetrate its outer sheath. Keep the whole insertion tube as straight as possible during operation; loops or bends anywhere in the tube decrease its ability to steer the probe tip. Avoid bending the insertion tube sharply.

**Note:** Always use the Home button to straighten the bending neck before withdrawing insertion tube from inspection area or putting probe away. Never pull, twist, or straighten the bending neck by hand; internal damage may result.

contact direct the probe for repair.

Certain substances may damage the probe. For a list of substances that are safe for the probe, see “Chemical Compatibility” in the Appendix.

## Battery Warnings

Only use the battery (XLGOABATTA or XLGOABATTB) and power supply (XLGOACHGR) specified for use with the XL Detect system. Before use, thoroughly review the instructions in this manual for the battery and battery charger to fully understand the information contained in them, and observe the instructions during use.

### WARNING

- Do not place the battery in fire or exceed the battery operating temperature.
- Do not pierce the battery with nails, strike the battery with a hammer, step on the battery, or otherwise subject it to strong impacts or shocks.
- Do not expose the battery to water or salt water, or allow the battery to get wet.
- Do not disassemble or modify the battery.



Battery Communication Error. Contact Customer Service at +1 866 246 2638.

Using the battery outside its recommended operating range will result in degradation of the performance and service life. When storing the battery, be sure to remove it from the base unit.

Recommended temperature range for Li-ion battery operation.

Discharge (when using the instrument): : -20° C to 46° C

Recharging : 0° C to 40° C

Storage : -25° C to +60° C

**Remarque** : avant l'utilisation ou l'entretien du système, vous devez lire et comprendre les informations de sécurité qui suivent.

### Symboles et termes employés

Les symboles suivants sont apposés sur le produit :





Voir la documentation jointe.

### Avertissements généraux

Les avertissements suivants s'appliquent à l'utilisation du système

en général. Les avertissements qui s'appliquent spécifiquement

 Le système XL Detect et les outils de travail qui l'accompagnent ne doivent jamais entrer en contact avec une source de tension ou de courant. Évitez tout contact avec des conducteurs ou des bornes électriques sous tension. L'équipement risquerait d'être endommagé, ou l'opérateur de subir un choc électrique.

 N'utilisez pas ce système dans un environnement à risque d'explosion.

 **UTILISER CORRECTEMENT.** Si un élément de cet équipement est utilisé d'une manière non indiquée par le fabricant, l'utilisateur peut ne plus être protégé des risques de blessure.

 Mentions générales « Attention »

Les mentions « Attention » qui suivent s'appliquent à l'utilisation de l'appareil XL Detect en général. Les mentions « Attention » qui s'appliquent spécifiquement à des procédures particulières sont indiquées dans les sections correspondantes du manuel.

 L'utilisation de la batterie en dehors de la plage de fonctionnement recommandée entraînerait une dégradation de ses performances et de sa longévité. Lorsque vous stockez la batterie, veillez à la retirer de sa base.

Plage de température recommandée pour le fonctionnement de la batterie Lithium-Ion.

Décharge (à l'utilisation de l'appareil) : -20°C à +46°C Recharge , 0°C à +40°C Stockage, -25°C à +60°C





**MANIPULER LA SONDE AVEC PRÉCAUTION.** Maintenez la gaine de la sonde à l'écart d'objets pointus ou tranchants qui risqueraient de traverser son fourreau. Maintenez toute la gaine aussi droite que possible pendant l'utilisation : en cas de boucle ou de courbure, il est plus difficile de piloter le bout de la sonde. Évitez de trop courber la gaine.

de traverser son fourreau. Maintenez toute la gaine aussi droite que possible pendant l'utilisation: en cas de boucle ou de courbure, il est plus difficile de piloter le bout de la sonde. Évitez de trop courber la gaine.

Remarque : utilisez toujours le bouton de rangement pour redresser le béquillage avant de rétracter la gaine de la zone d'inspection ou de ranger la sonde. Ne manipulez jamais le béquillage à la main pour le tirer, le courber ou le redresser : vous risqueriez de l'endommager à l'intérieur. Envoyez la sonde en réparation au premier signe d'endommagement.

Certaines substances risquent d'endommager la sonde. Pour consulter la liste des substances sans danger pour la sonde, voir Compatibilité Chimique en annexe.

### **Avertissements liés à la batterie**



Utilisez uniquement la batterie (XLGOABATTA or XLGOABATTB) et l'alimentation (XLGOACHGR) spécifiées pour être utilisées avec le système XL Detect.



Avant utilisation, lisez attentivement les instructions contenues dans ce manuel relatives à la batterie et au chargeur de batterie pour bien les comprendre, et respectez ces instructions pendant l'utilisation de l'appareil.



### **AVERTISSEMENT**

- Ne jetez pas la batterie au feu et ne dépassez pas sa température de fonctionnement.
- Ne percez pas la batterie avec des clous, ne la frappez pas avec un marteau, ne marchez pas dessus et ne la soumettez pas à des impacts ou des chocs violents.
- N'exposez pas la batterie à l'eau douce ou salée, et évitez de la mouiller.
- Ne désassemblez pas la batterie et ne la modifiez pas. Erreur de communication de la batterie. Veuillez contacter le Service clientèle au numéro +1 866 243 2638.

# 3 Setup

## System Removal

Gently remove the insertion tube and handset from the storage case.

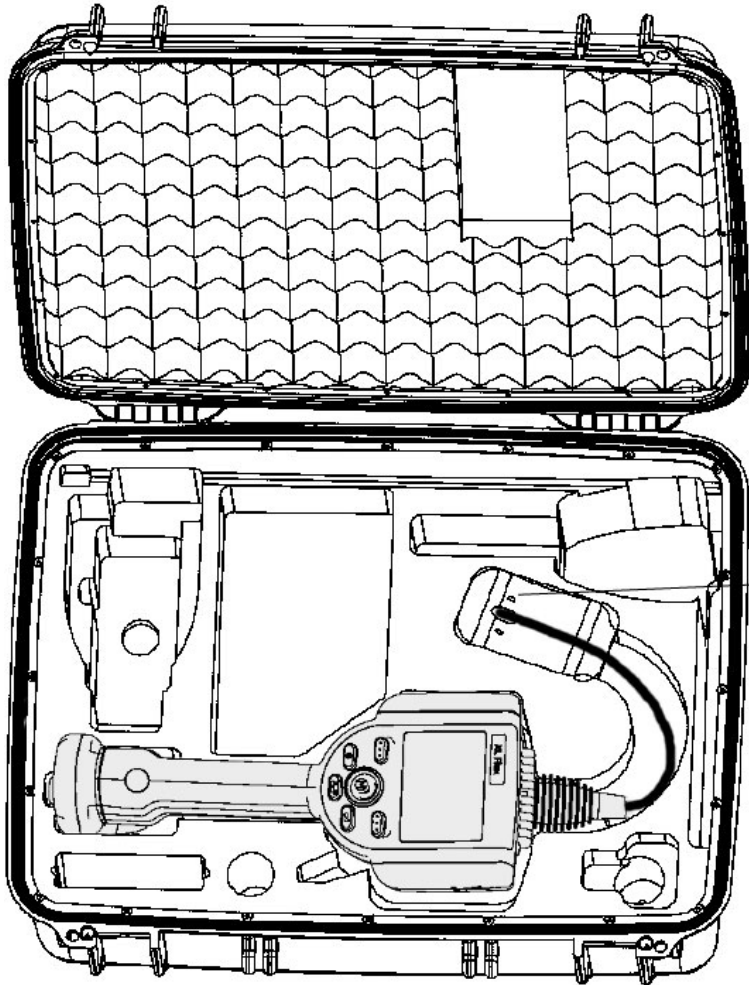

## System Power On

Press and hold the  Power/Exit key briefly to power on. The buttons and Liquid Crystal Display (LCD) will light and begin the power-up sequence. After approximately 30 seconds, the system screen will display live video and screen prompts. The system is now ready for use.

**Note:** All batteries are shipped with a partial charge. Batteries should be fully charged prior to use.

## System Power Off

Press and hold the  Power/Exit key until the “SYSTEM SHUTTING DOWN” message appears. Key illumination and LED probe lights will go out when system is completely powered down.

## System Storage

Carefully coil the insertion tube into the case storage reel. Place the XL Detect handset into the designated foam cutout. LCD screen should face up.

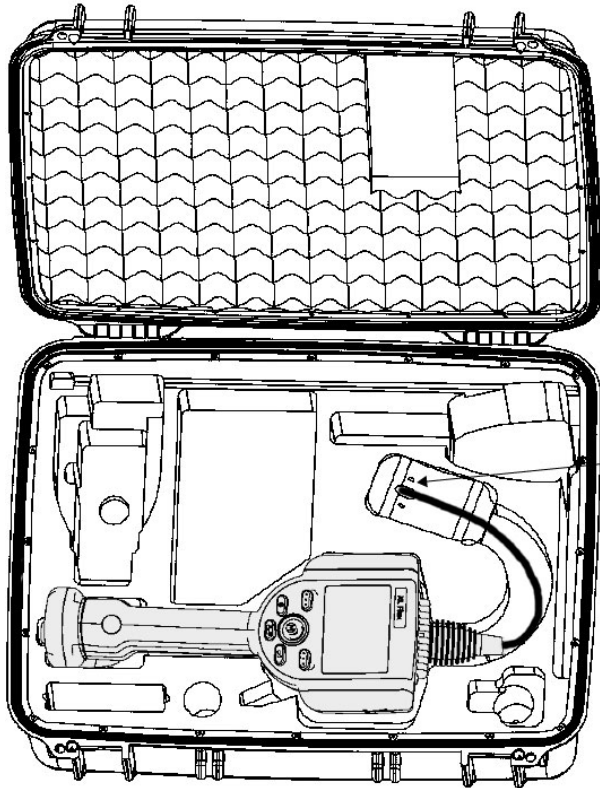

## Mounting Accessories

Assemble the optional mounting accessories by screwing together the mini magic clamp, swivel ball, and handset holder.

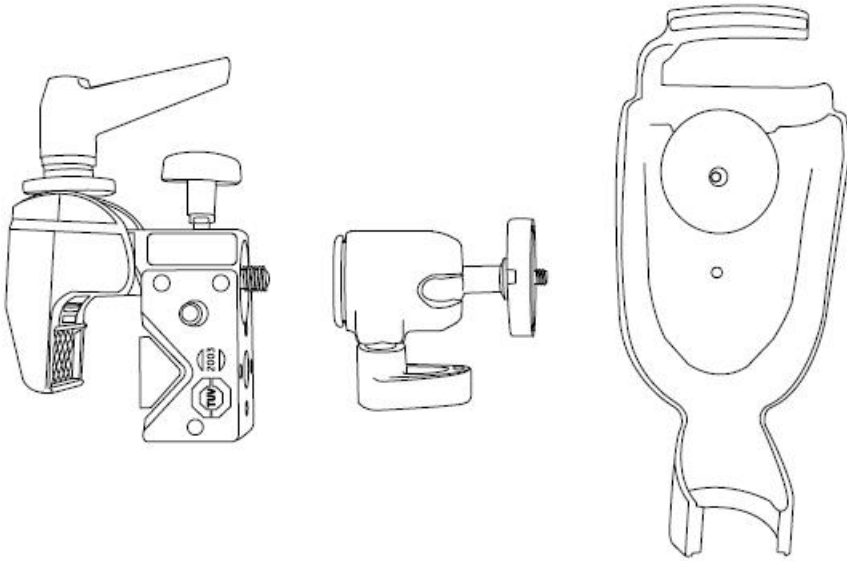

Secure the XL Detect mini magic clamp and place the XL Detect system in the handset holder.

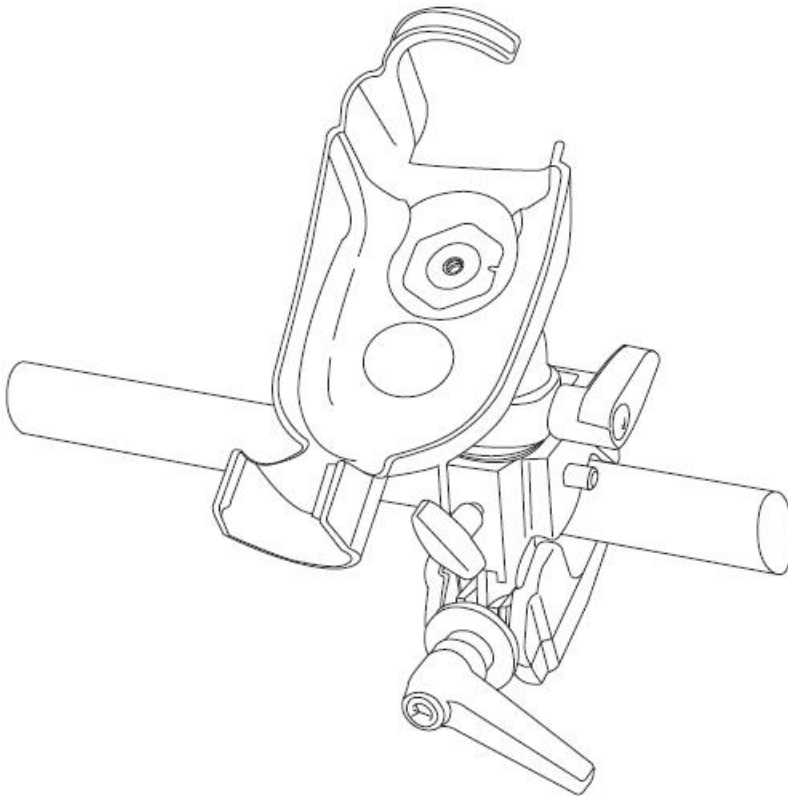

## Battery

## Installing Battery

Insert the battery into the handset. The battery is installed properly when the latching mechanism is engaged.

**Note:** Do not force the battery into the handset, as damage may occur. The battery is keyed and may only be installed in the proper orientation.

## Removing Battery

For batteries with the removal tab: Using your hand, turn the tab counterclockwise and release the battery. Do not use a tool to remove the battery.

For batteries with the locking screw: Using a slotted screwdriver or coin, turn the locking screw counterclockwise and release the battery.

**Note:** Do not remove battery while system is operating.

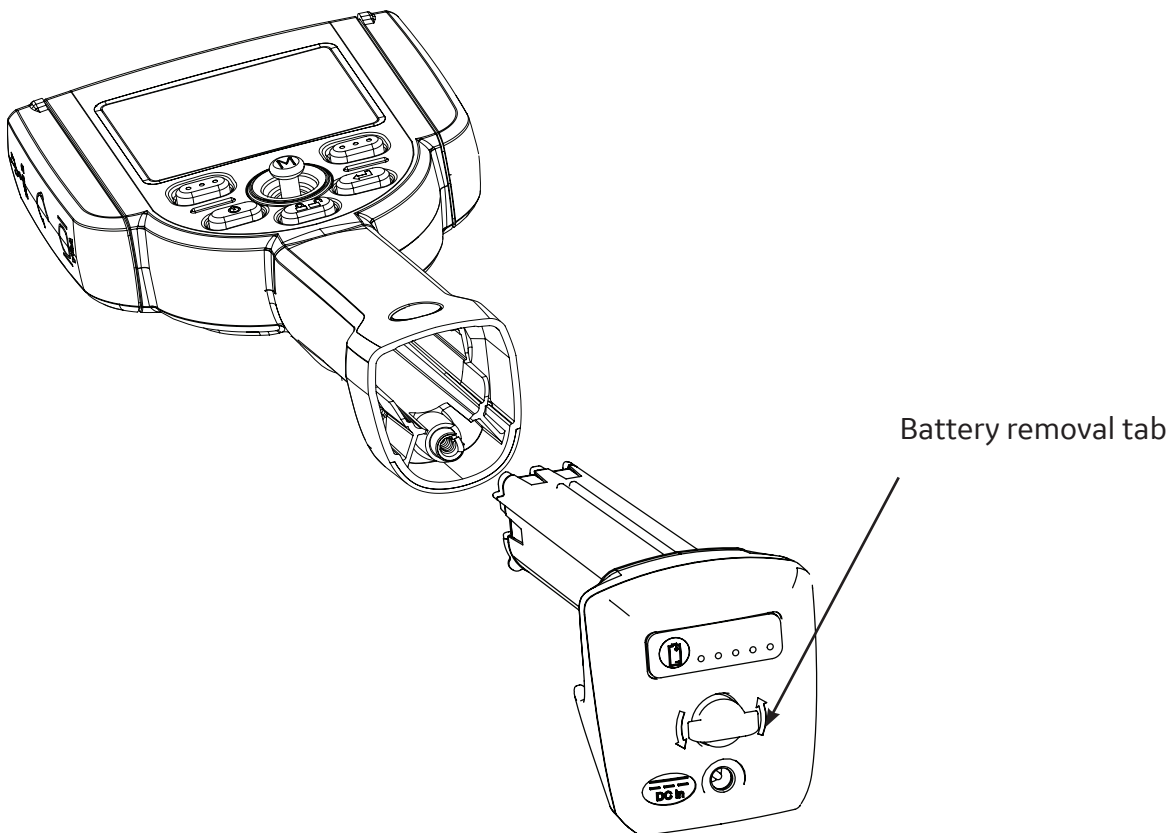

## Battery Charge Level

Check the battery charge by pressing the battery symbol on the front of the battery. Each light represents approximately 20% of the battery charge capacity.

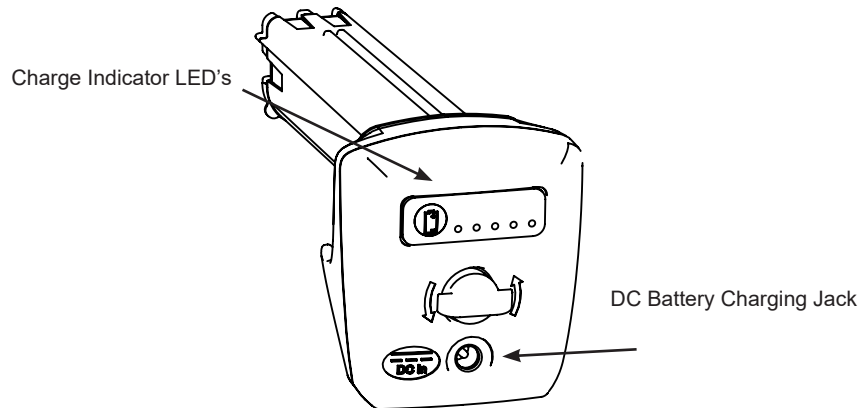

## Charging Battery

Plug the included XLGOACHGR power adaptor into a suitable AC power source and connect the DC output of the battery charger into the XL Detect battery. The LED battery lights will illuminate according to the amount of charge attained. The system may operate while charging.

The battery may also be charged while disconnected from the system. When the battery is fully charged, the LED battery lights will turn off.

**Note:** Battery run time typically equals battery charge time; therefore, a four hour battery will take approximately four hours to charge.

## Keyboard Support

To use an external, USB keyboard, plug the approved device into one of the two USB ports.

For a list of approved keyboards, contact your sales representative or customer support.

The function keys on the keyboard act as the keys on the XL Detect

F1: Menu Function on Joystick

F2: Left Soft Key - 

F3: Power/Exit Key - 

F4: Steer & Stay Key - 

F5: Enter Key - 

F6: Right Soft Key - 

**Note:** Keyboards only support the top level functions and will not support the press and hold functions such as video recording.

# Saving Images and Video

## Still Images

To capture a still image, compose the picture and press and release  Freeze/Enter.

Press the  right soft key with SAVE on the LCD above to save to the default location.

Alternately, from live video, press and hold  Freeze/Enter to quick-save.

## Video

To record live video, press and hold the  left soft key labeled RECORD on the LCD above. A red record symbol will appear in the upper right hand corner. When the video is stopped, it will automatically save to the default location.

## Optical Tips

Optical tips are attached to the insertion tube using a double thread. This prevents unintended departures of optical tips from the probe. Each optical tip provides a unique depth of field (DOF), field of view (FOV) and direction of view (DOV). A complete list of available tips is provided in the Appendix.

## Optical Tip Removal

1. Grasp the head of the probe with one hand and gently loosen the tip counterclockwise with the other hand. The tip has cleared the first set of threads when it spins freely.
2. Gently pull the tip away from the probe and continue loosening counterclockwise until the tip is free from the second set of threads.

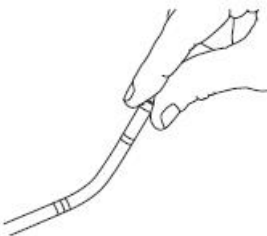



## Optical Tip Installation

1. Ensure the optical tip is clean. Clean if necessary (See Cleaning Optical Tips).
2. Grasp the head of the probe with one hand and gently turn the tip clockwise with the other hand. The tip has cleared the first set of threads when it spins freely and then seats when gentle force is applied.
3. Gently push the tip onto the probe and continue turning clockwise on the second set of threads until the tip is attached finger tight. **Do NOT over tighten.** Pull gently on the tip to ensure proper attachment to the probe.

**NOTE:** Never use tools or excessive force to install or remove an optical tip.

### Tip Tool Proper Use (4.0 mm only)

#### Removing Tips

1. Apply empty tip tool to probe head.
2. Apply pressure while turning in the counter-clockwise position.
3. When tip tool spins freely, gently pull up while twisting in the counter-clockwise position to release the second set of threads.
4. Remove tip tool and tip will be within.

#### Applying Tips



1. Apply tip tool containing appropriate tip to probe head.
2. Apply pressure while turning in the clockwise position.
3. When tip tool spins freely, gently push down while twisting in the clockwise position to engage the second set of threads.
4. Pull gently on tip tool to ensure proper attachment.
5. Remove tip tool and tip will be attached to probe head.

**NOTE:** Never use excessive force to install or remove an optical tip.

# 4 Operation

## GO TO Menu

Many common operating tasks are available in the GOTO menu. This menu is available by pressing

the right soft key  labeled GOTO during live video mode. To exit any menu, press Power/Exit .

## GO TO > File Manager

To enter the file manager, navigate to FILE MANAGER with the joystick and select with the right soft key labeled SELECT.



## GO TO > Eject Hardware

To eject USB thumb drives before removal, use the joystick to navigate to the right of EJECT HARDWARE and select USB1 using the right soft key labeled SELECT.

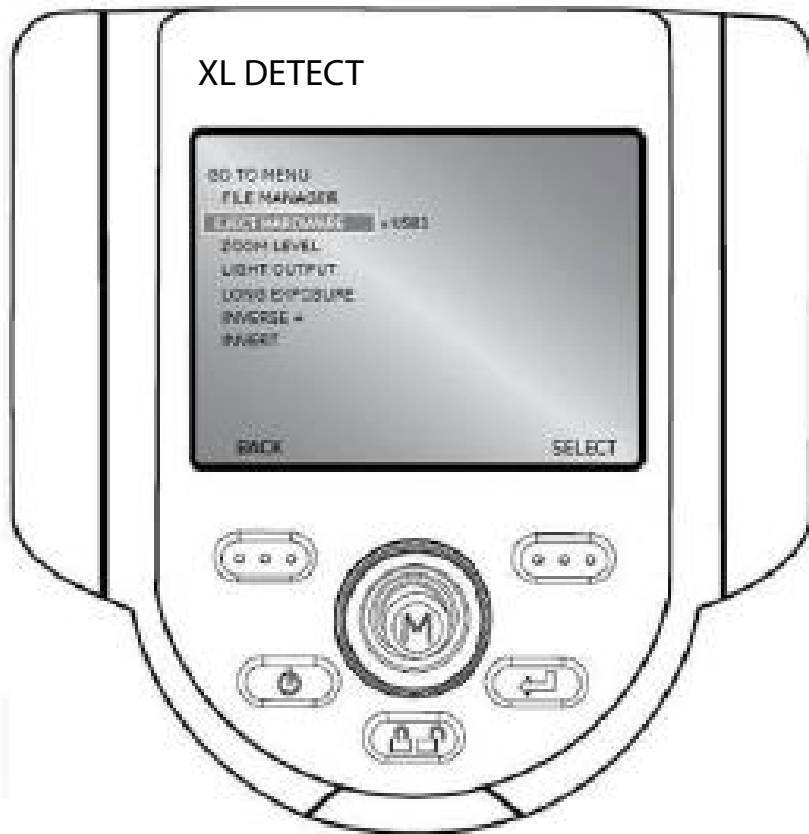

**Note:** Always use EJECT HARDWARE before removing a USB thumb drive to prevent loss of data.

## GO TO > Zoom Level

An image can be zoomed from 1 (normal view) to 5 (5 times zoomed). Navigate to the right of ZOOM LEVEL and use the joystick to adjust the zoom level.

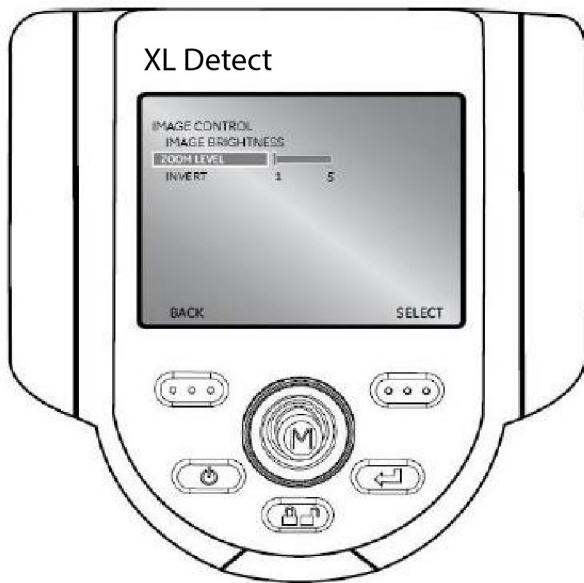

## GO TO > Light Output

To turn the LED optical light On or Off, navigate to the right of LIGHT OUTPUT and select ON or OFF.

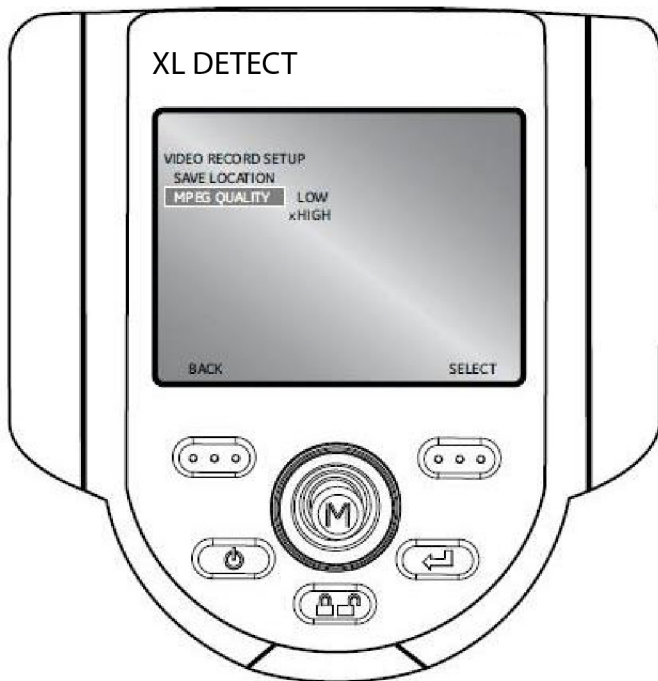

**Note:** Turning on  FREEZE FRAME is a convenient way to turn off the light output and is ideal for changing optical tips and conserving battery charge.

## GO TO > Long Exposure

The XL Detect system can brighten the image by varying the exposure time. Keep the probe tip as still as possible when capturing an image with long exposure to minimize the risk of blurring.

Select LONG EXPOSURE to choose manual exposure, automatic long exposure, or to turn long exposure off. Long Exposure may be turned off in live video mode by pressing the Power/Exit key.

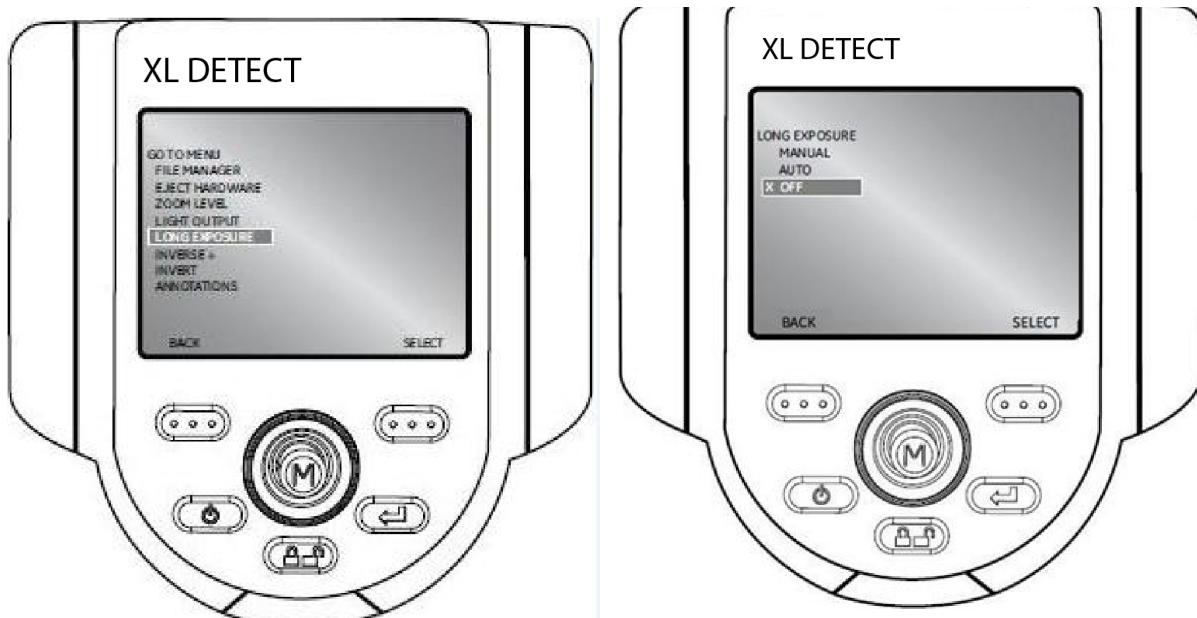

After selecting Long Exposure, the following options will be available:

- MANUAL
- AUTO
- OFF

## GO TO > Inverse +

Inverse + reverses the brightness similar to a photographic negative. It enhances the image contrast, making subtle details more visible. Inverse + may be turned off in live video mode by pressing the Power/Exit key .

To activate or deactivate, navigate to INVERSE + and choose ON or OFF.

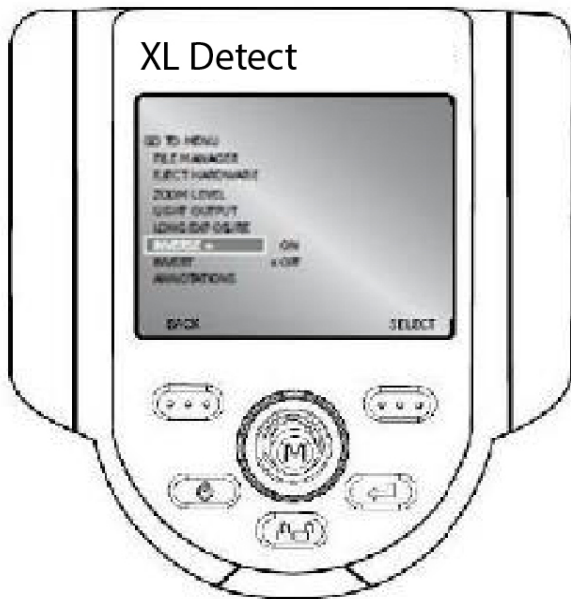

## GO TO > Invert

The invert function flips an image horizontally. To activate or deactivate, navigate to INVERT and choose ON or OFF. Invert may be turned off in live video mode by pressing the Power/Exit key. 



## GO TO > Annotations

When Annotations have already been added to the image, user can quickly remove them by choosing ANNOTATIONS > DELETE ALL.

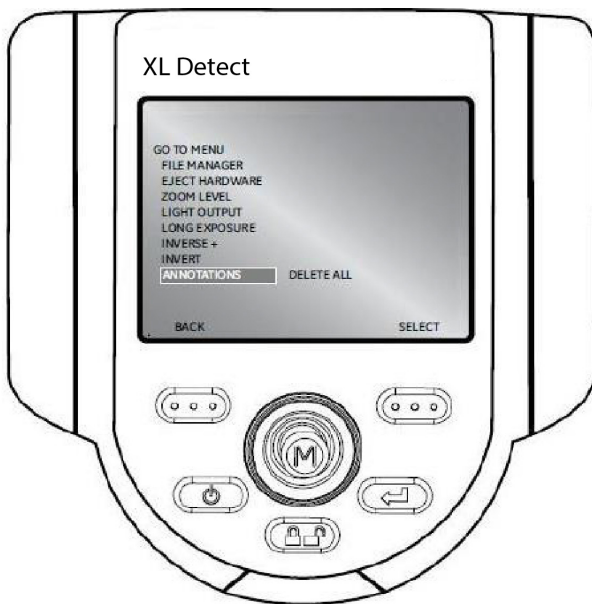

## Live Main Menu

To activate the LIVE MAIN MENU, press and release the joystick.

To exit any menu, press  Power/Exit.

## Live Main Menu > Light Output

To turn the LED optical light on/off, use the joystick to choose LIGHT OUTPUT and select ON or OFF.

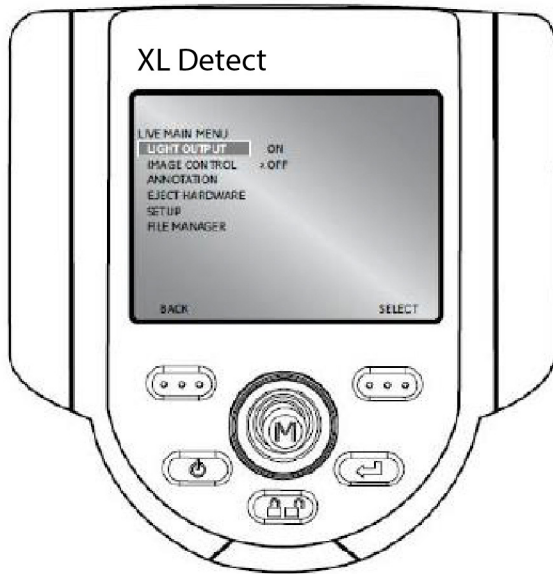

**Note:** Turning on FREEZE FRAME is a convenient way to turn off the light output and is ideal for changing optical tips. For Battery models this also conserves battery charge.



## Live Main Menu > Image Control

From the LIVE MAIN MENU, select IMAGE CONTROL. The changes made to the Image Controls take effect immediately.

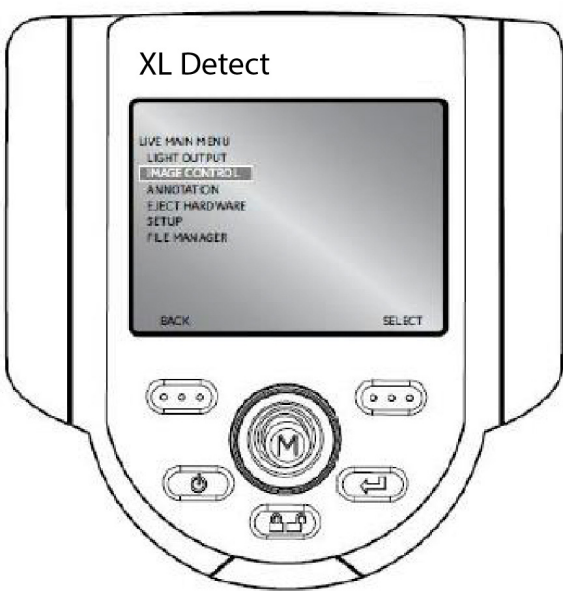

The following options are then available:

- Image Brightness
- Zoom Level
- Invert

**Note:** By pressing the  power/exit key twice, any image control features will be turned off and returned to factory default settings.

## Live Main Menu > Image Control > Image Brightness

Navigate to IMAGE BRIGHTNESS from the IMAGE CONTROL Menu and use the joystick to adjust the image brightness.



## Live Main Menu > Image Control > Zoom Level

Navigate to ZOOM LEVEL from the IMAGE CONTROL Menu and use the joystick to adjust the zoom level. Digital zoom levels from 1x to 5x may be selected.



## Live Main Menu > Image Control > Invert

The invert function flips an image horizontally. To activate or deactivate Invert, navigate to INVERT from the IMAGE CONTROL MENU and select ON or OFF.

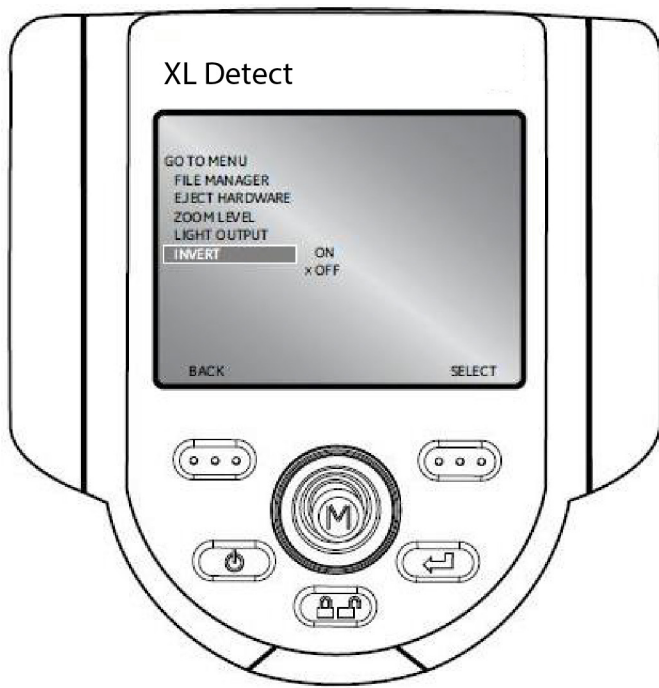

**Note:** This feature is most useful when using Side-view Optical Tips.

## Live Main Menu > Annotation

Annotating an XL Detect image means adding text or arrows to describe or point out areas of interest: cracks, defects, etc. Annotation may be used on live, frozen, and recalled images.

To alter the annotation settings, press the joystick to activate the LIVE MAIN MENU and select ANNOTATION.

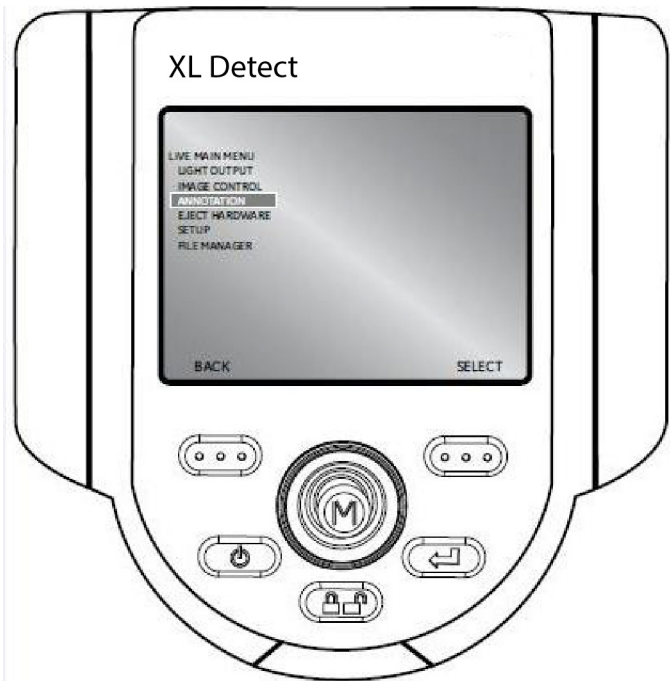

**Note:** There is a maximum of 3 lines of text/arrows per annotation.

**Note:** See the Freeze Frame Menu to enable Audio Annotation.

## Live Main Menu > Annotation > Text

To add, edit, or clear text on a specific image, select TEXT from the ANNOTATION menu.

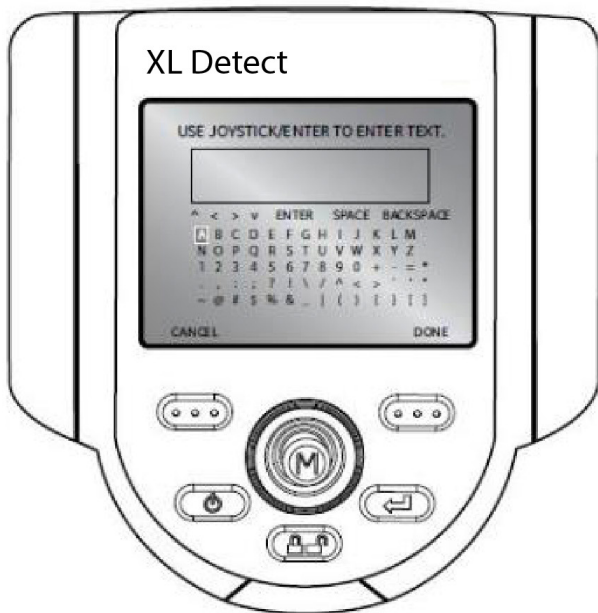

**Note:** Maximum number of text annotations is 50.

## Live Main Menu > Annotation > Arrow

To add, edit or clear arrow on a specific image, select ARROW from the ANNOTATION menu.

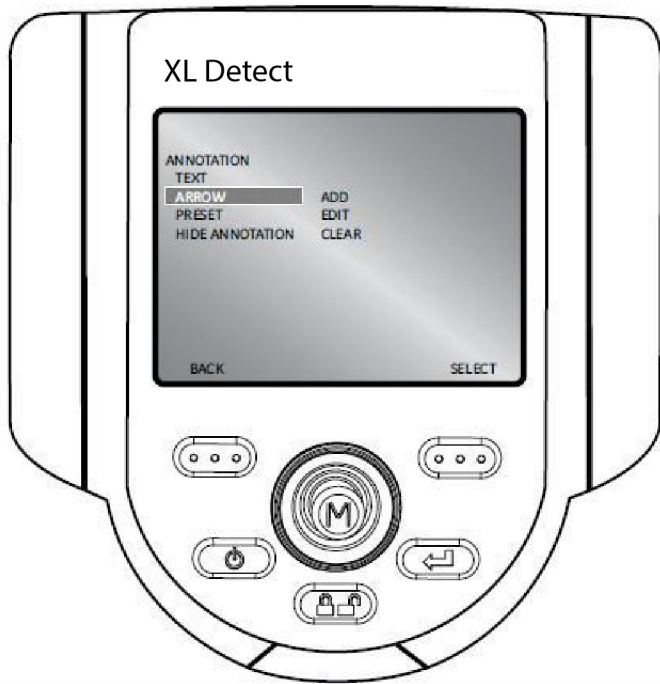

**Note:** Maximum number of arrow annotations is 25.

## Live Main Menu > Annotation > Preset

To create, recall or delete a preset annotation that will display throughout an inspection, choose PRESET from the ANNOTATION menu.



**Note:** Maximum number of preset annotations is 100.



## Live Main Menu > Annotation > Hide Annotation

To hide or un-hide an annotation, select HIDE ANNOTATION from the ANNOTATION menu followed by ON or OFF.

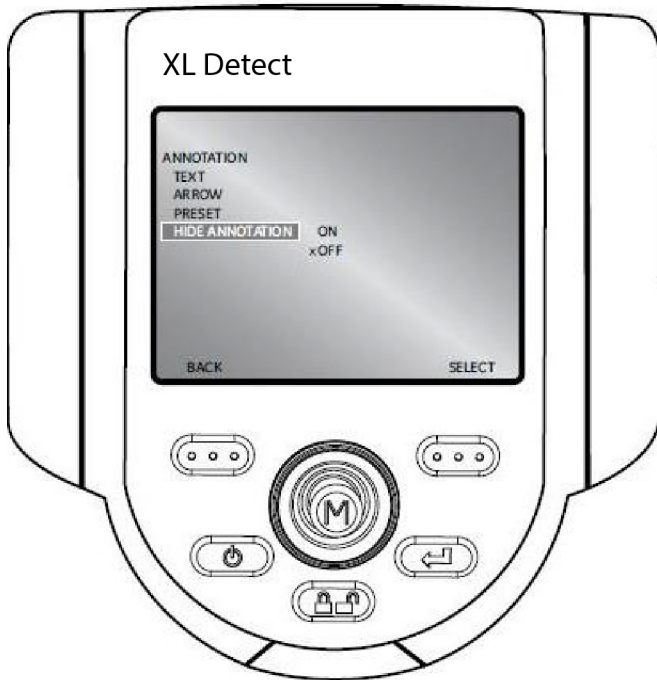

**Note:** Always use EJECT HARDWARE before removing a USB thumbdrive to prevent loss of data.

## Live Main Menu > File Manager

To manage files and folders on the XL Detect VideoProbe system, select FILE MANAGER with the joystick. For more details refer to the FILE MANAGEMENT section in the Operation Chapter.



## Live Main Menu > Eject Hardware

To eject USB thumb drives before removal, use the joystick to navigate to the right of EJECT HARDWARE and select USB1 using the right soft key labeled SELECT.

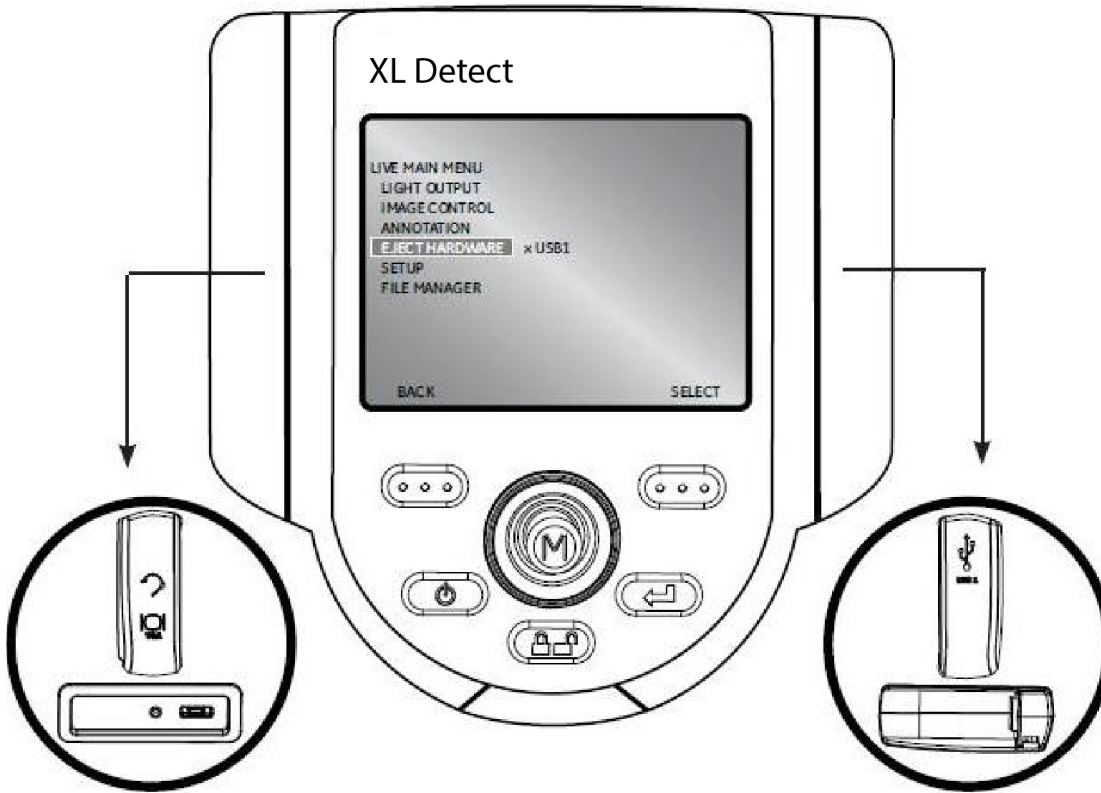

## Live Main Menu > Setup

To change default settings, select SETUP. For more information see SYSTEM SETUP Section in the Operation Chapter.

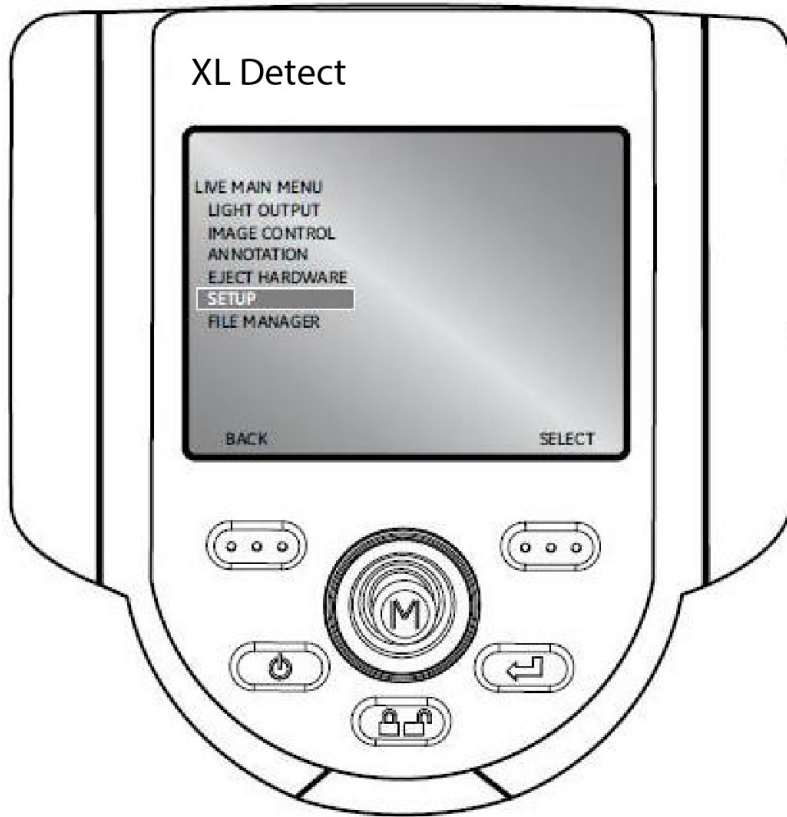

## Live Main Menu > Setup

The System Setup Menu accesses the default settings. To exit any menu, press



Power/Exit.

## Live Main Menu > Setup > Screen/Display Setup

To alter the display setup, press the joystick to activate the LIVE MAIN MENU. Select SETUP followed by SCREEN/DISPLAY.

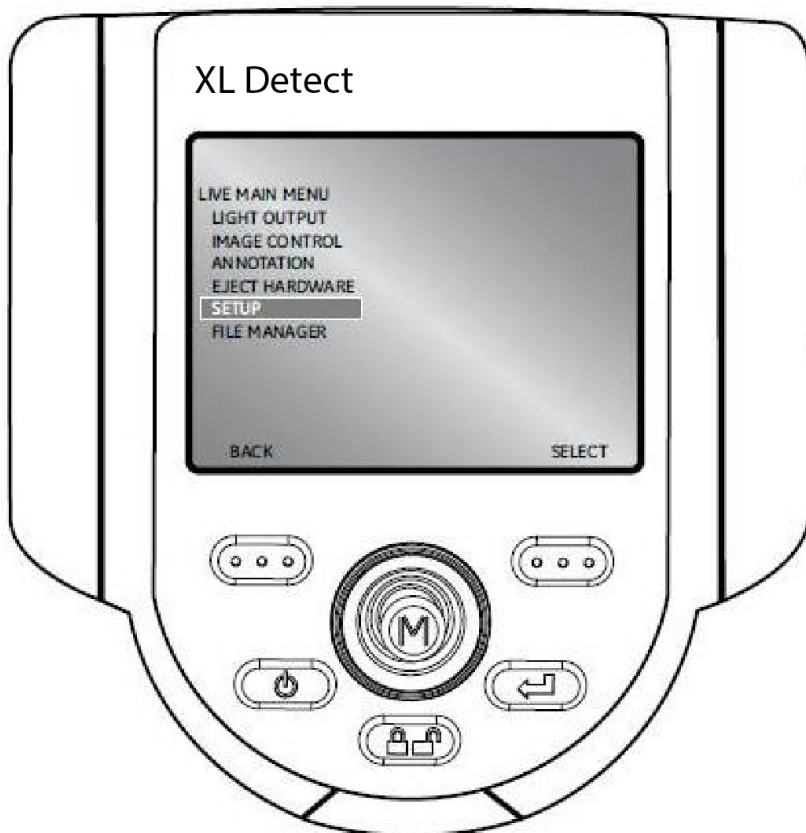

## Live Main Menu > Setup > Screen/Display Setup > Battery Icon

To enable and disable the battery icon, select BATTERY ICON followed by ON or OFF.

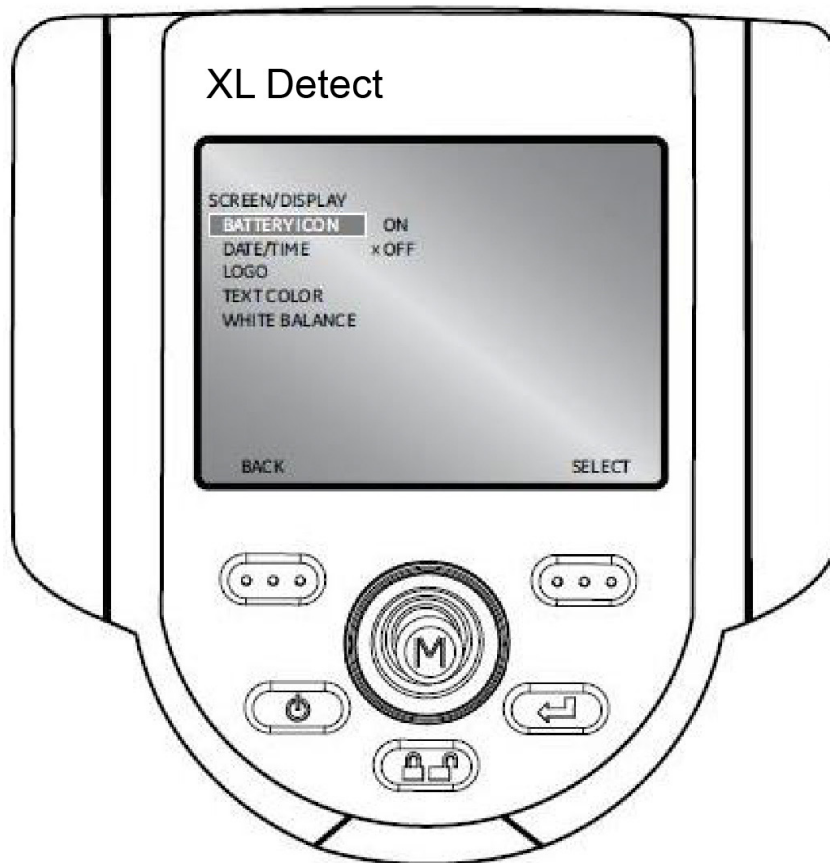

**Note:** See Appendix D for details on creating a logo file.

## Live Main Menu > Setup > Screen/Display Setup > Date / Time

To enable or disable the date/time stamp, as well as set the date and time, select DATE/TIME from the SCREEN/DISPLAY menu.

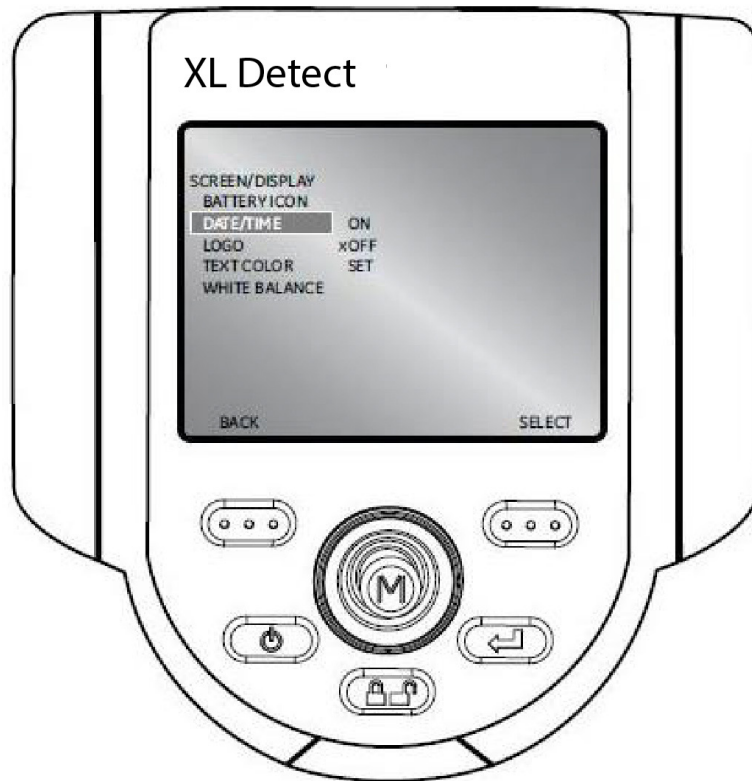

## Live Main Menu > Setup > Screen/Display Setup > Logo

A logo may be added to the screen. The file name “logo.jpg” must be used. To load a logo, or to turn a logo on or off, select LOGO from the SCREEN/DISPLAY menu and select the desired option.

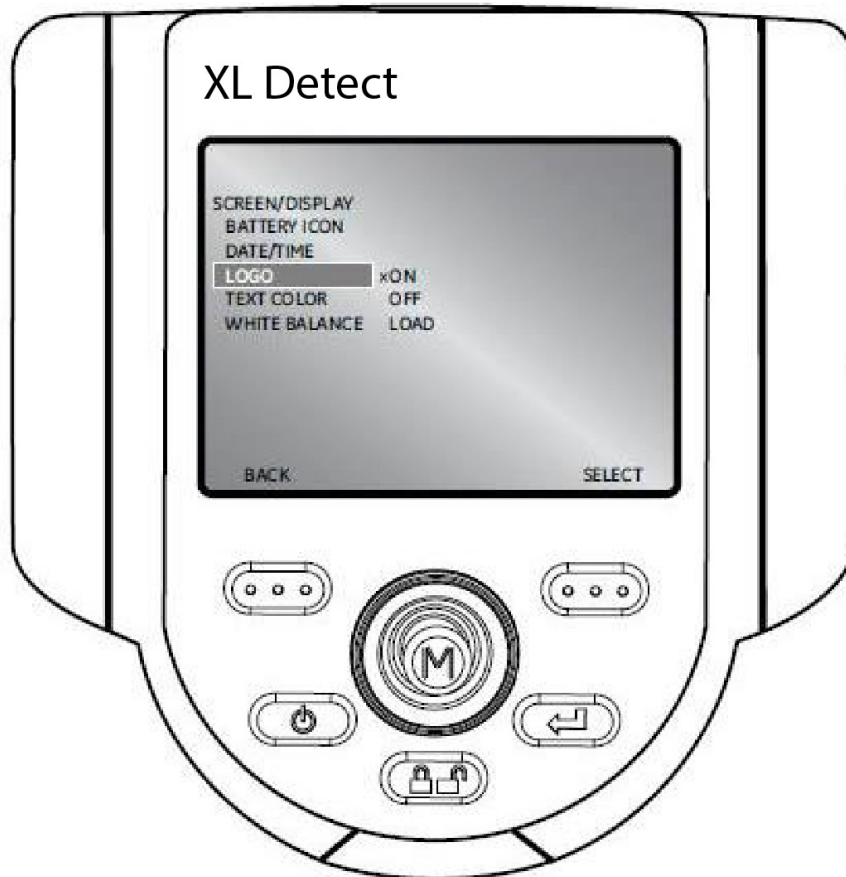



## Live Main Menu > Setup > Screen/Display Setup > Text Color

The most legible text color will vary with the coloring and brightness of the image. To change the color of the text displayed over images, select TEXT COLOR followed by GREEN, BLACK, or WHITE.

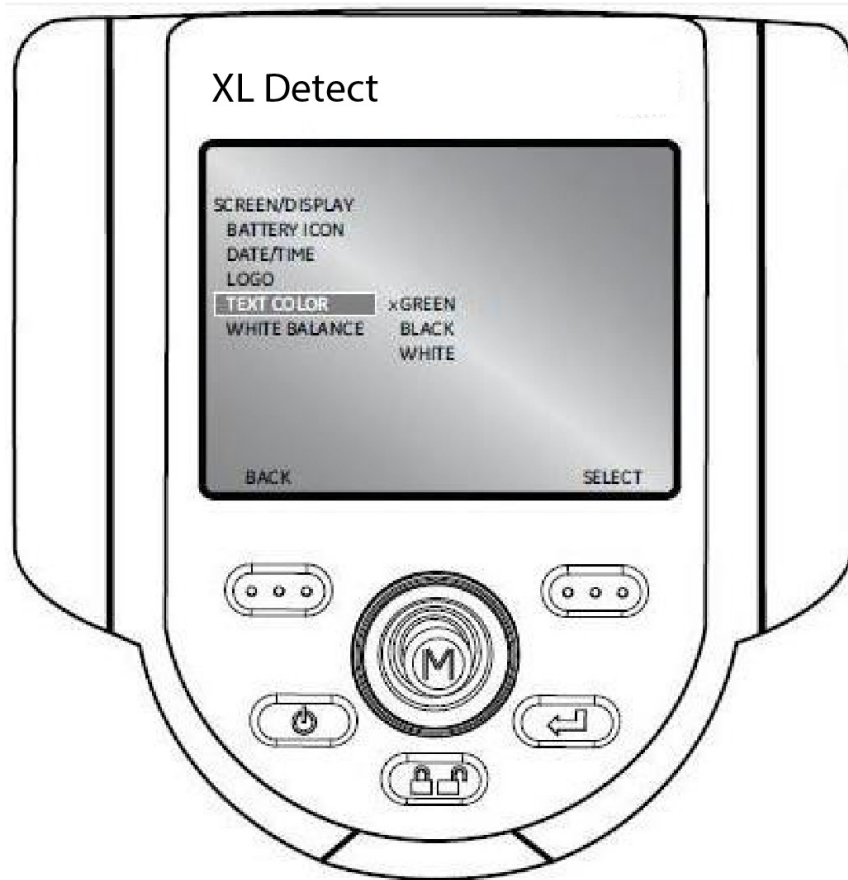

## Live Main Menu > Setup > Screen/Display Setup > White Balance

White balance corrects color so white appears white despite any slight hues that may be present under varying lighting and ambient conditions.

To execute white balance, select WHITE BALANCE from the SCREEN/ DISPLAY menu. Options are to set a custom white balance or use the default settings.

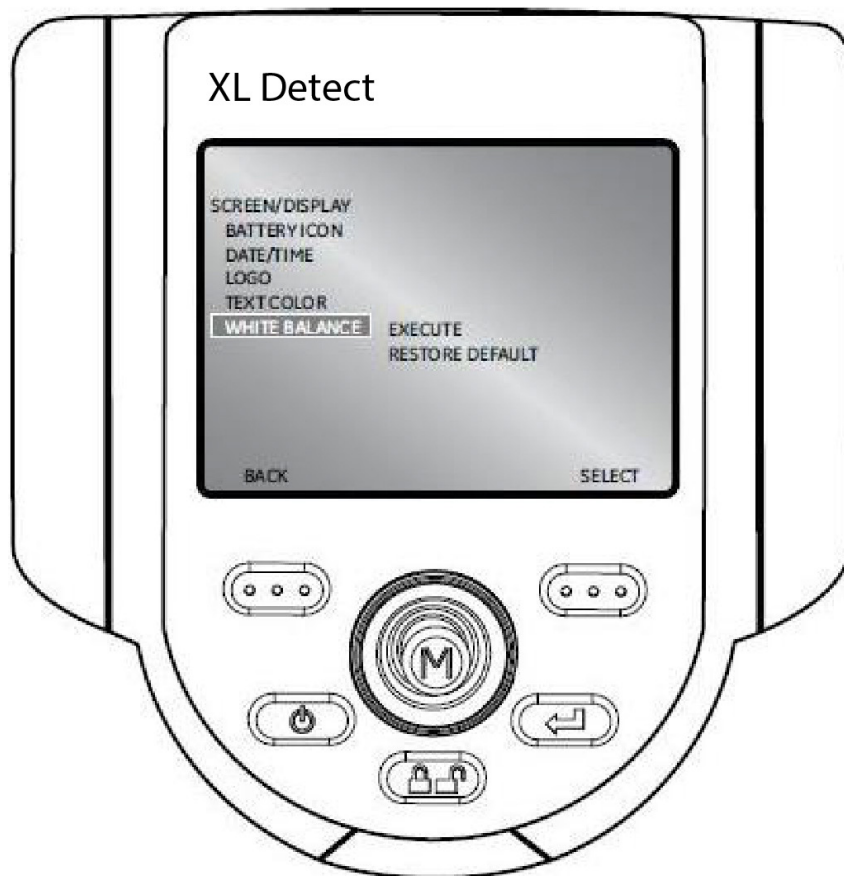

## Live Main Menu > Setup > Video Record Setup

To change video record defaults, press the joystick to activate the LIVE MAIN MENU. Select SETUP followed by VIDEO RECORD SETUP.

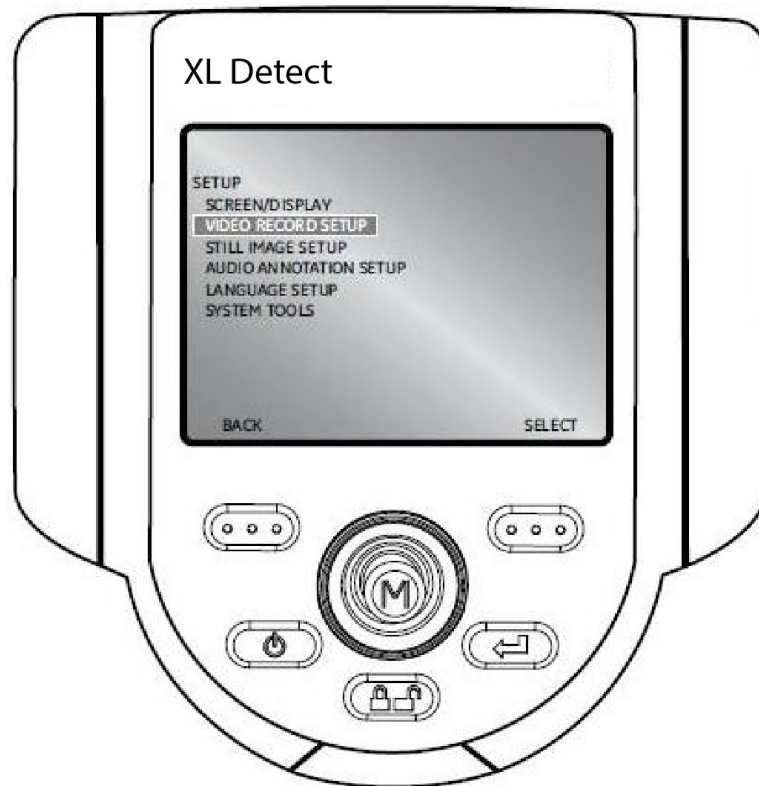

## Live Main Menu > Setup > Video Record Setup > Save Location

Select SAVE LOCATION from the VIDEO RECORD SETUP menu and navigate to the desired location.



## Live Main Menu > Setup > Video Record Setup > MPEG Quality

To set the video quality, select MPEG QUALITY from the VIDEO RECORD SETUP menu followed by LOW or HIGH.

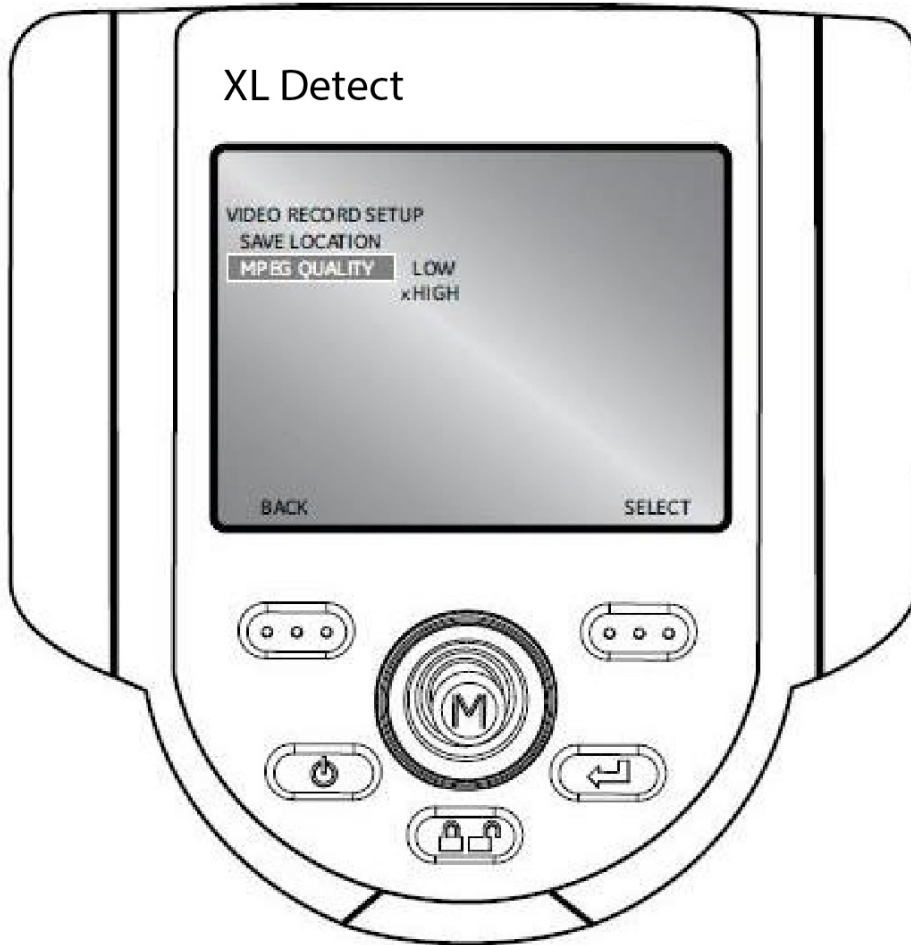

## Live Main Menu > Setup > Still Image Setup

To change still image defaults, press the joystick to activate the LIVE MAIN MENU. Select SETUP followed by STILL IMAGE SETUP.

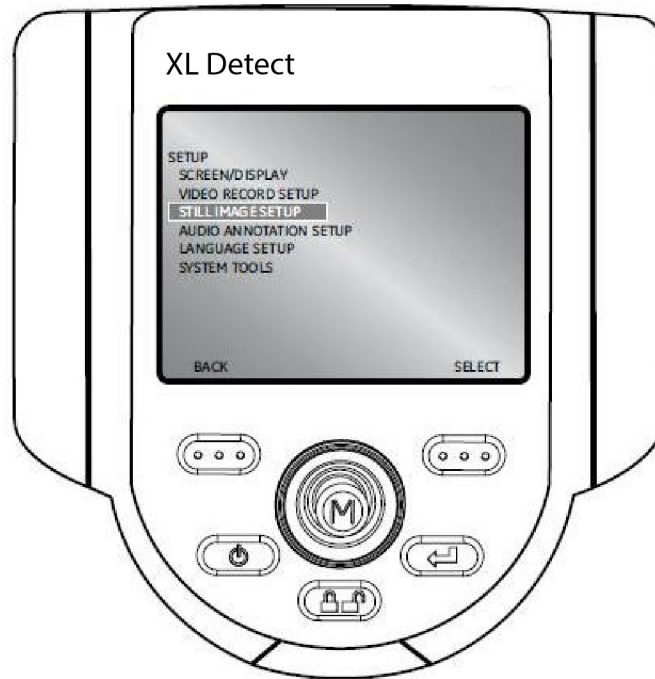

## Live Main Menu > Setup > Still Image Setup > Save Location

Select SAVE LOCATION from the STILL IMAGE SETUP menu and use the joystick to navigate to the desired location.

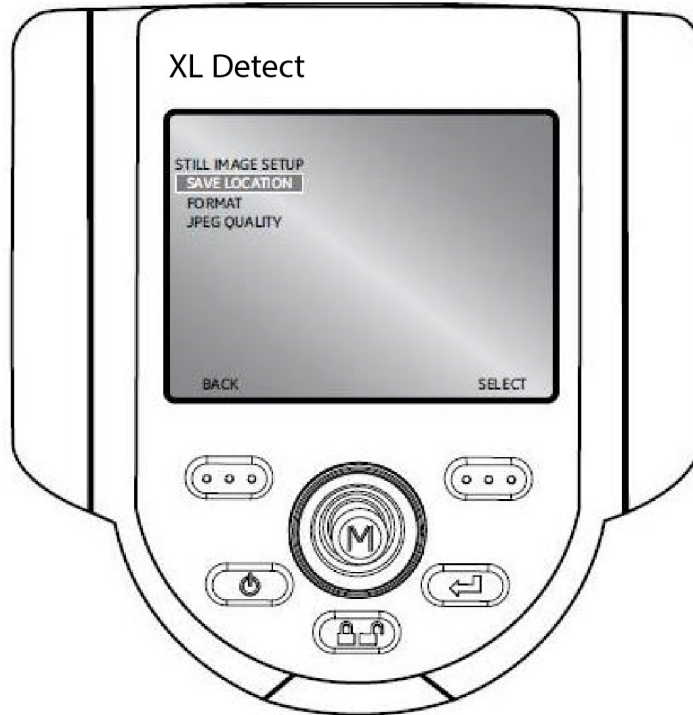

## Live Main Menu > Setup > Still Image Setup > Format

To choose the image format [Bitmap (BMP) or JPEG (JPG)], navigate to the right of FORMAT and select BMP or JPG.





## Live Main Menu > Setup > Still Image Setup > JPEG Quality

To choose JPEG quality, the user must first select JPEG image format. Once selected, navigate to the right of JPEG QUALITY and select LOW or HIGH.

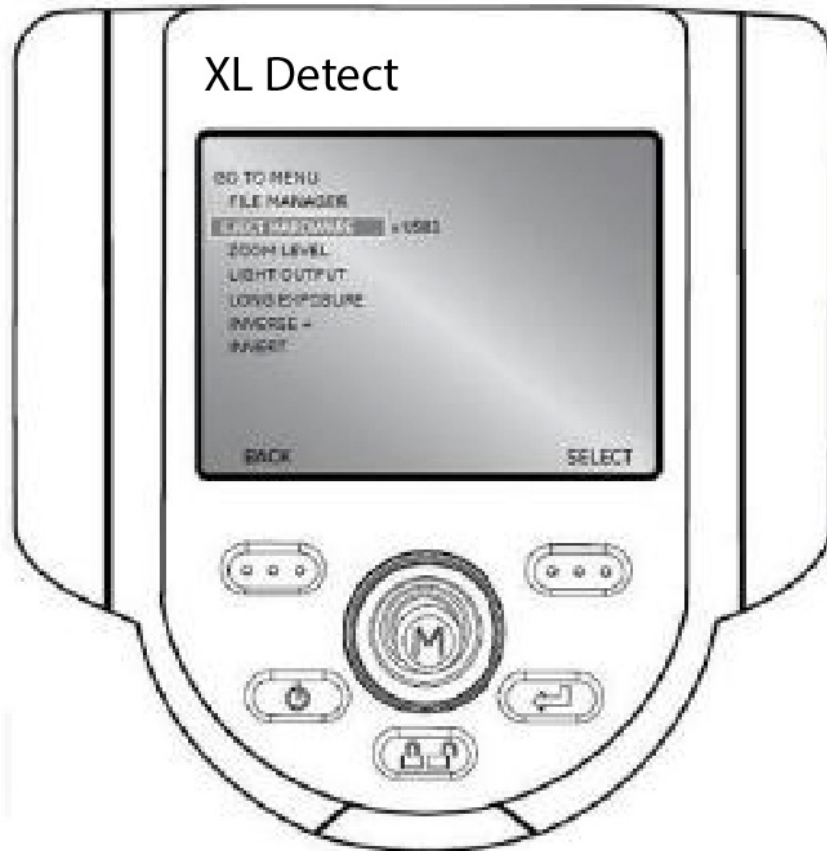

## Live Main Menu > Setup > Audio Annotation Setup

To change audio defaults, press the joystick to activate the LIVE MAIN MENU. Select Setup followed by AUDIO ANNOTATION SETUP.

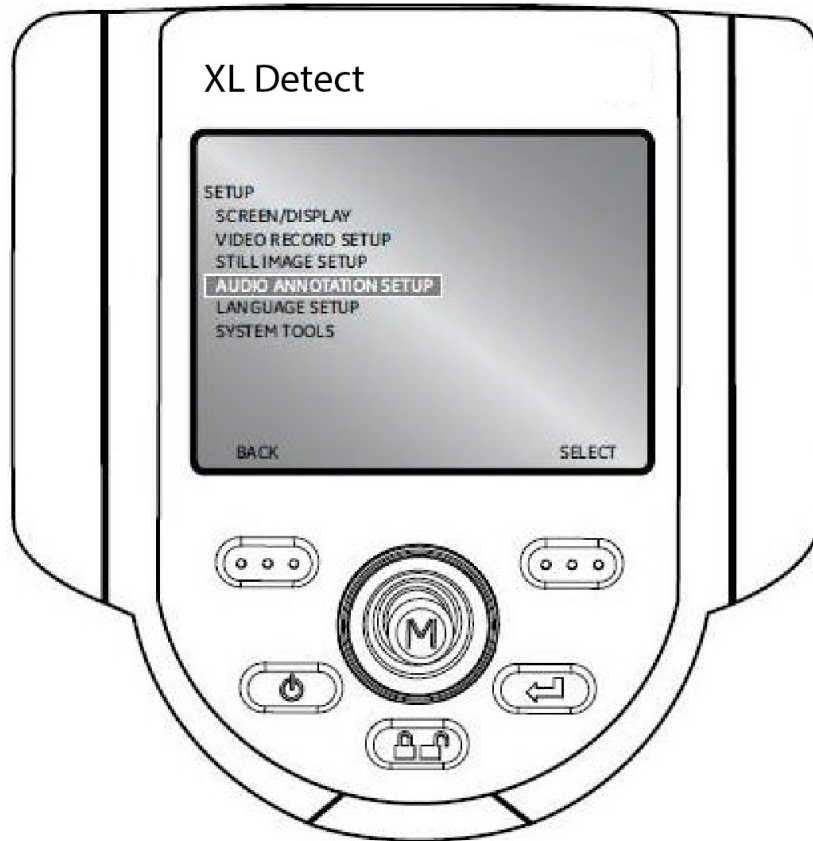

**Note:** To access AUDIO ANNOTATION, press the Joystick from a frozen image. Select ANNOTATION followed by AUDIO. The following options will be available:

- RECORD
- PLAY
- DELETE

## Live Main Menu > Setup > Audio Annotation Setup > Playback Volume

To set the playback volume, select PLAYBACK VOLUME from the AUDIO ANNOTATION SETUP menu.

Use the joystick to control the volume from 0 to 10.

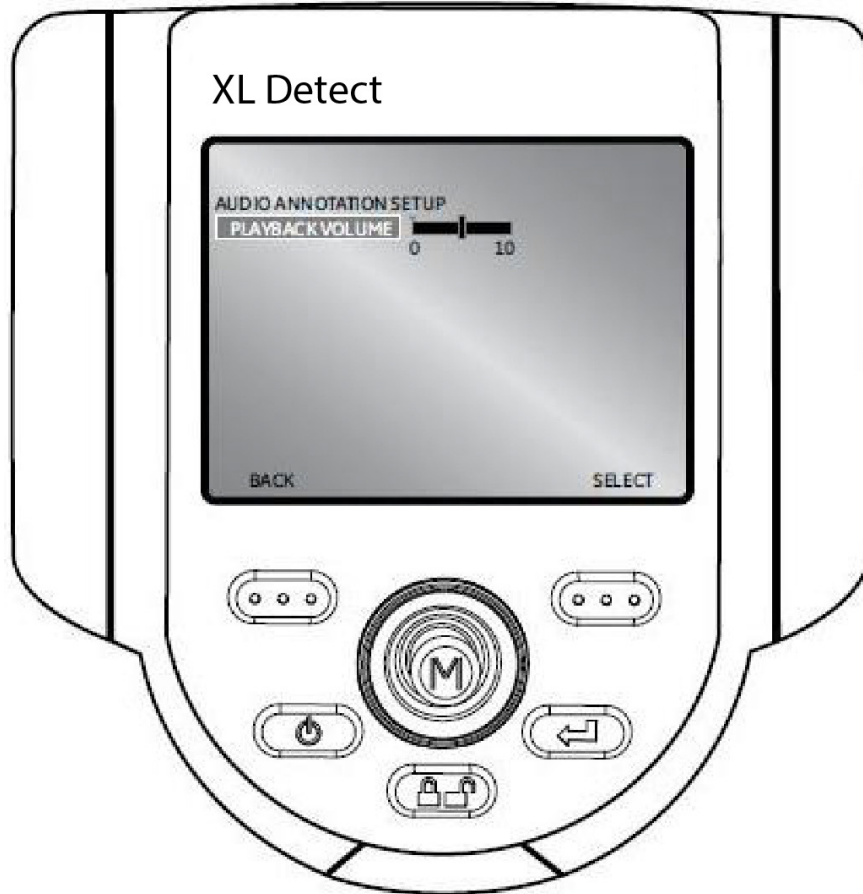

## Live Main Menu > Setup > Language Setup

To load or change the system language, select LANGUAGE SETUP from the SETUP menu followed by the appropriate language.

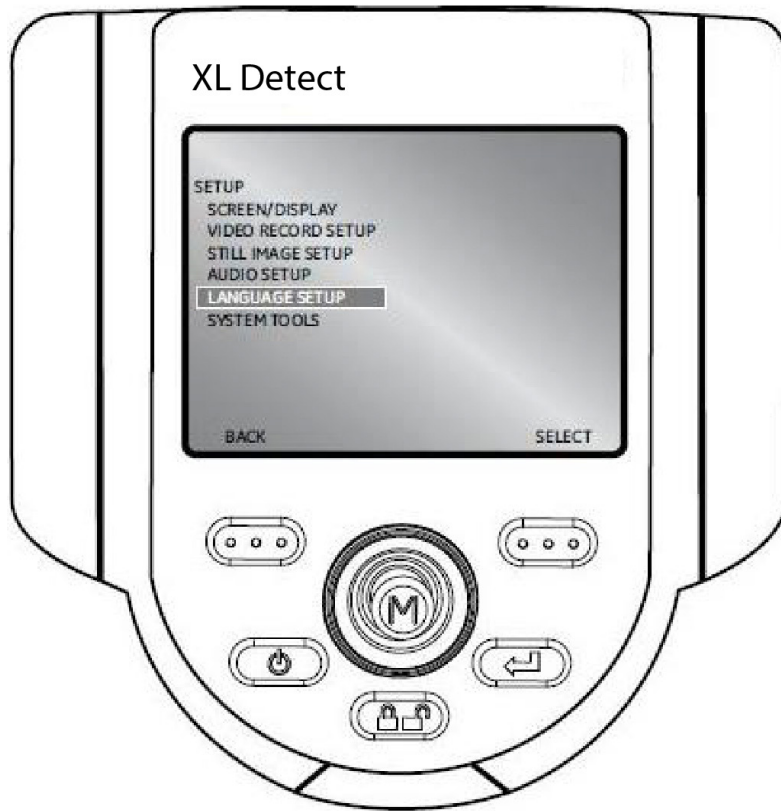

The following options are available:

- LOAD
- CHANGE

## Live Main Menu > Setup > System Tools

To view system information or adjust power management, select SETUP from the LIVE MAIN MENU followed by SYSTEM TOOLS.

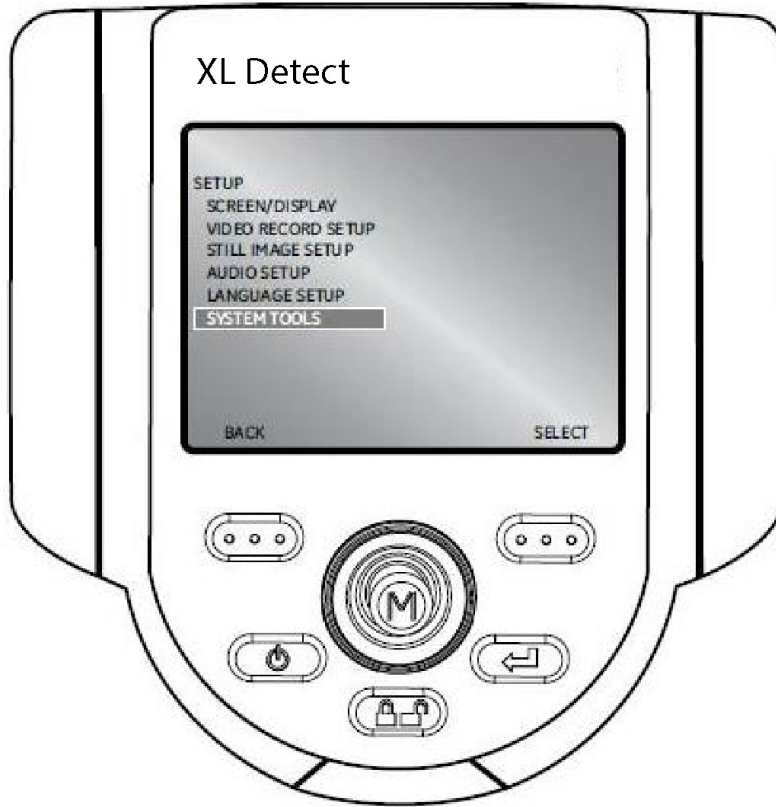

## Live Main Menu > Setup > System Tools > System Info

To view system information such as the software version or the amount of free disk space, select SYSTEM INFORMATION from the SYSTEM TOOLS menu.

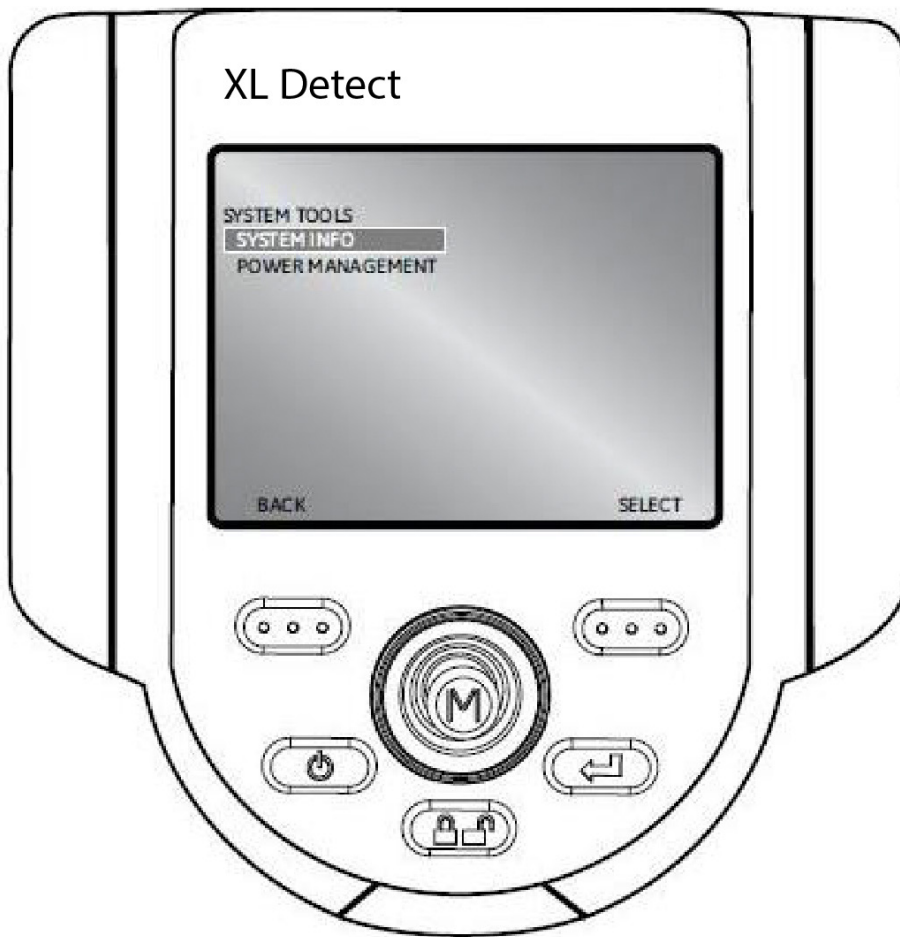

# 5 Inspecting

## Capturing Images and Video



### Steering the VideoProbe

The joystick controls articulation (steering) of the probe tip. When viewing a live video image, move the joystick towards the desired inspection area.

### Articulation Lock



To hold the bending neck in place while steering, press and release the  Steering Control key.

A  lock icon will appear in the corner of the display to symbolize steer and stay is enabled. The probe will now stay in place when the joystick is released.

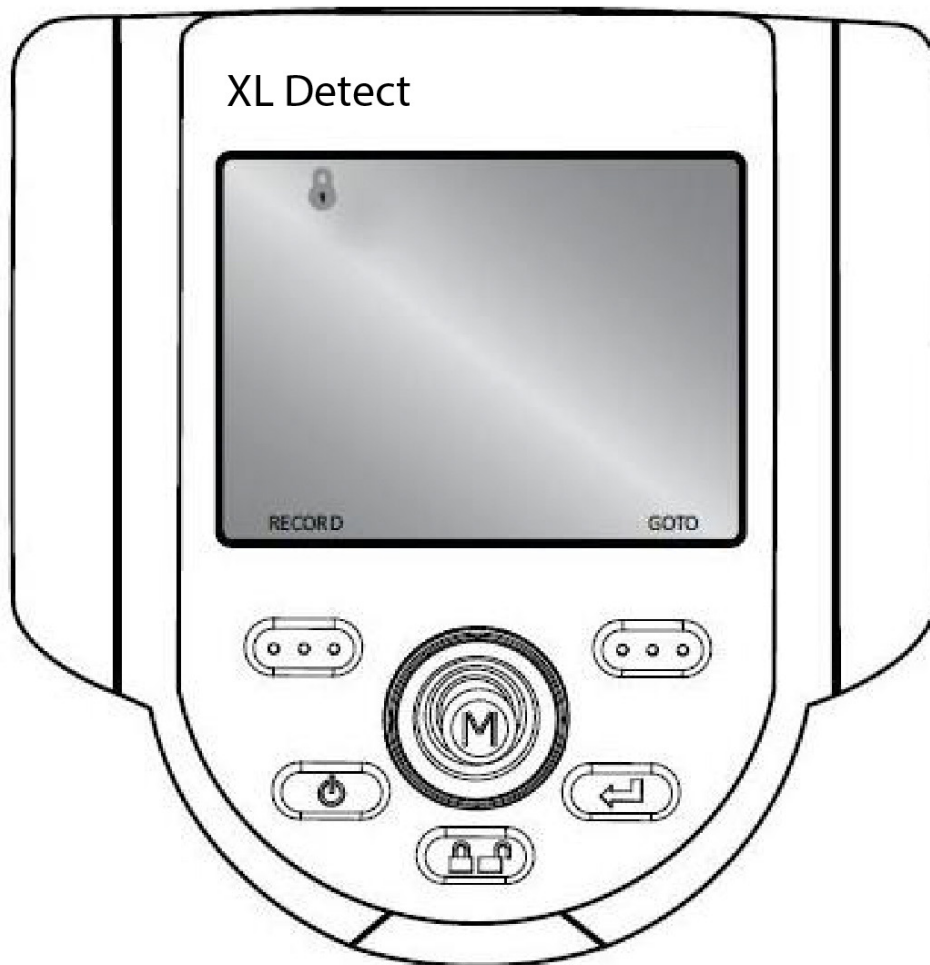
To unlock steering, press and release  Steering Control again. The  lock icon will disappear.



## Articulation Home

Press and hold  to engage functions. To straighten bending neck, press . A blinking home icon will appear on LCD when enabled.

 HOME icon will disappear when system is finished.

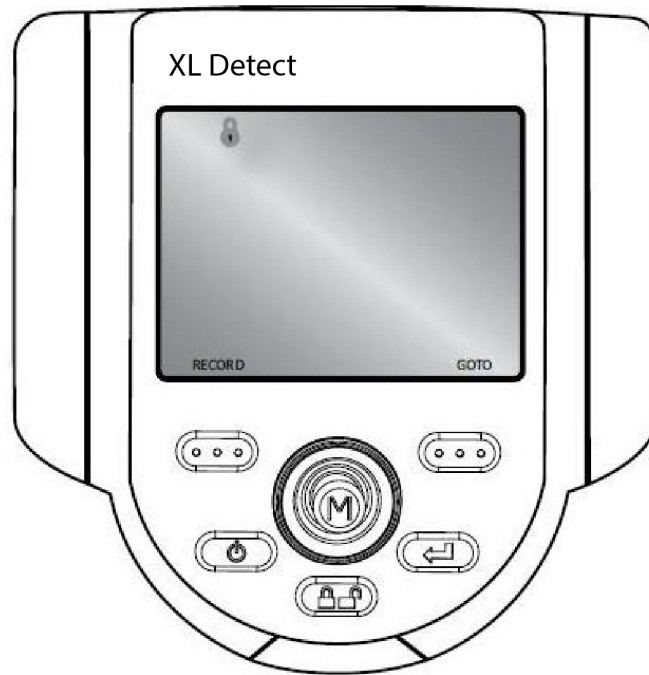



## Freeze Frame

Once the inspection area is in view, the image must be frozen before it can be measured or saved.

To freeze an image, press  Freeze/Enter. An “FF” will appear in the upper right corner of the display to symbolize that the image is frozen.

To disable Freeze Frame, press  Freeze/Enter again. The “FF” will disappear.

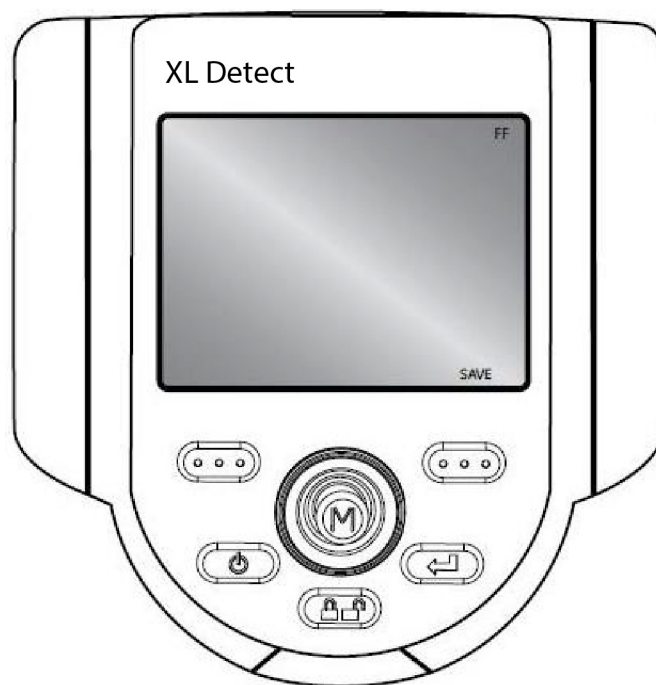

## Freeze Frame Menu

Once Freeze Frame is enabled, press the joystick to enter the FREEZE FRAME MENU.



The following options are available:

- SAVE AS
- ANNOTATION

## File Manager

To access the FILE MANAGER, press the joystick to activate the LIVE MAIN MENU. Navigate to FILE MANAGER and select.

### File Manager > Recall

To recall a file, select RECALL. Move the joystick to the right to locate the file(s) and use the right soft key to select. 

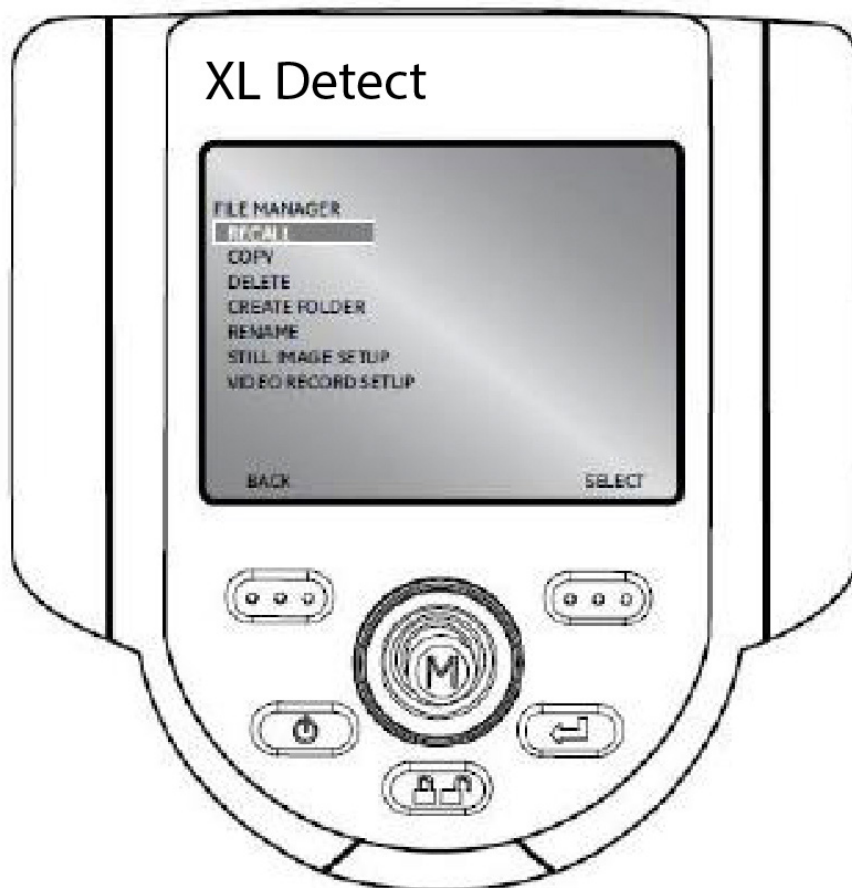

## Recalled Image Menu

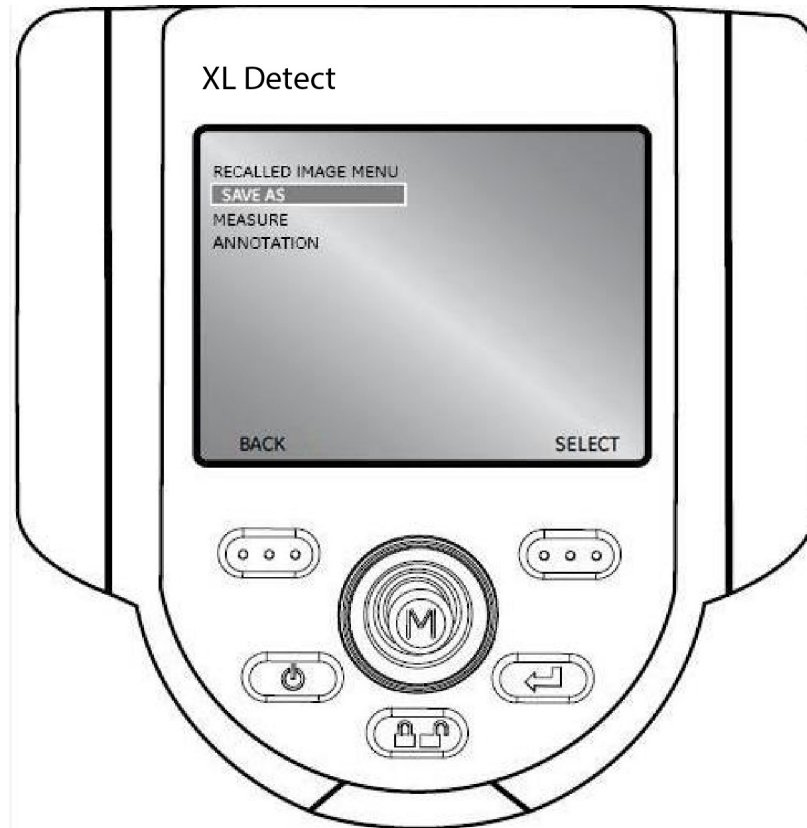

After recalling an image, press the joystick to activate the RECALLED IMAGE MENU.



The following options are available:

- SAVE AS
- MEASURE
- ANNOTATION

## File Manager > Copy

To copy a file, select COPY. Move the joystick to the right to locate the file(s) and use the right soft key  to mark/unmark. Press  Freeze/Enter to copy.

Choose the destination for the copied file. Use the joystick to navigate to the desired folder.

Press  Freeze/Enter to paste the copied file.

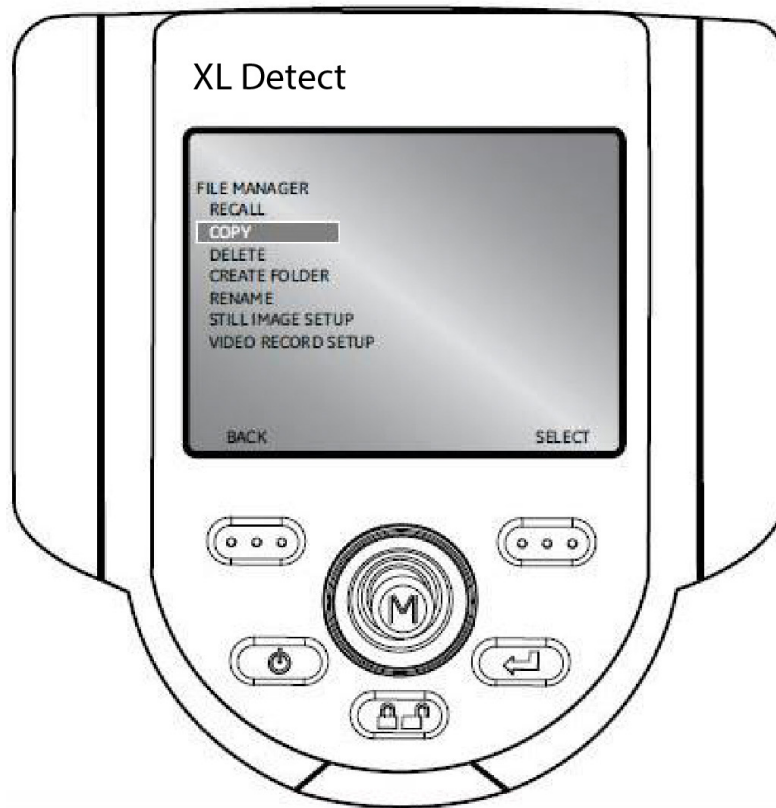



## File Manager > Delete

To delete a file, select DELETE FILE. Move the joystick to the right to locate the file(s) and select.

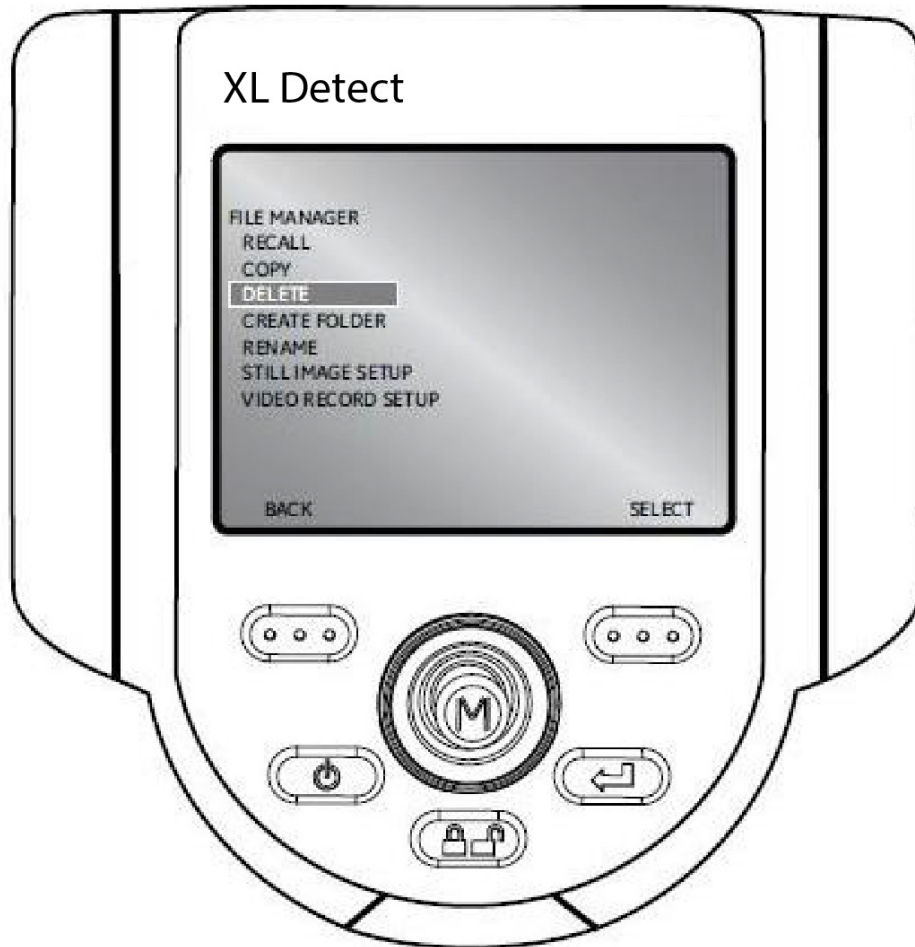
 Press Freeze/Enter to delete.



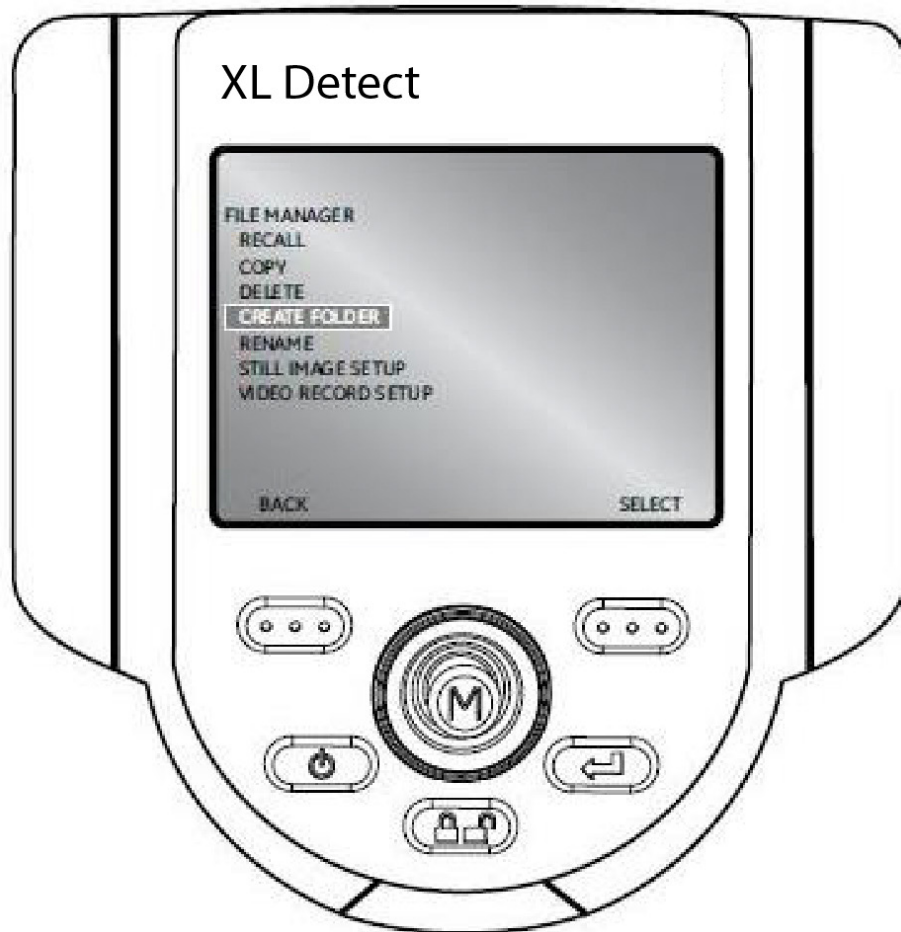

## File Manager > Create Folder

To create a folder, select CREATE FOLDER. Select the location of the folder. Use the joystick to highlight and  Freeze/Enter to select each letter. When done, press the  right soft key to save the folder name.



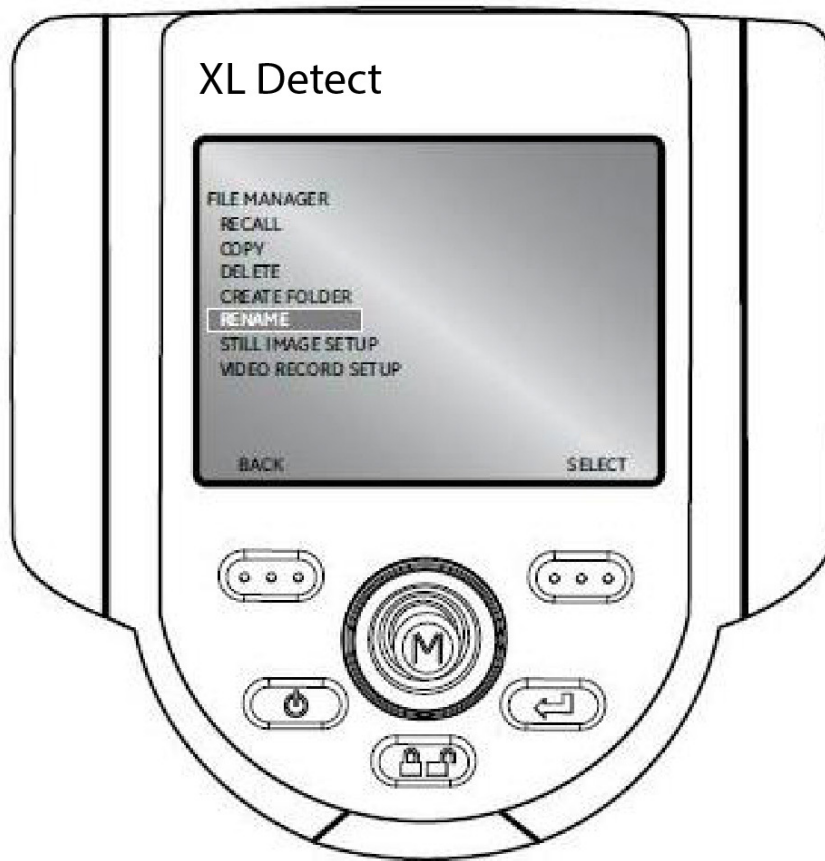

## File Manager > Rename

To rename a file, select RENAME. Navigate to the desired file/folder and use the  right soft key to select. Use the joystick to highlight and  Freeze/Enter to select each letter. When finished, press the  right soft key to save the file name.





## File Manager > Still Image Setup

To save/capture a still image if freeze frame is enabled, press the  right soft key with SAVE on the LCD above to save to the default location. Alternately, press and hold  Freeze/Enter to auto-save.

## File Manager > Video Record Setup

To record live video, press the  left soft key labeled RECORD on the LCD above. A record symbol will appear in the upper right hand corner. When the video is stopped, it will automatically save to the default location.



To view recorded videos, use either QuickTime or VLC software. Both are included with the system, located on the documentation CD.

## Video Playback Menu

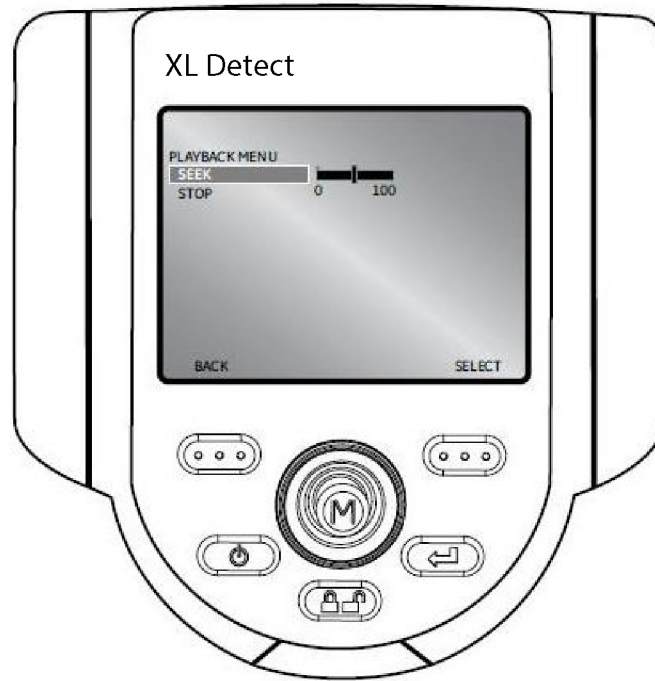

After recalling a video, press the left soft key to pause the video.  
Press the joystick to enable the PLAYBACK MENU.



The following options are available:

- SEEK
- STOP

### Note:

- Use the joystick to navigate through the video.
- Press the  right soft key to select the new playback start location.
- Press the  left soft key to return back to the video playback starting scene.
- Press the  left soft key to resume the video playback.

## Menu Directed Inspection (MDI)

Menu Directed Inspection (MDI) is the first software tool to standardize the inspection process in the NDT industry. MDI software helps guide inspectors through the inspection process and intelligently auto-generates a report—saving time, improving quality and increasing productivity.

Menu Directed Inspection (MDI) software provides an advantage and convenience during the inspection process. MDI makes labeling images and videos easier and automatically generates reports from the Video-Probe within a few steps.

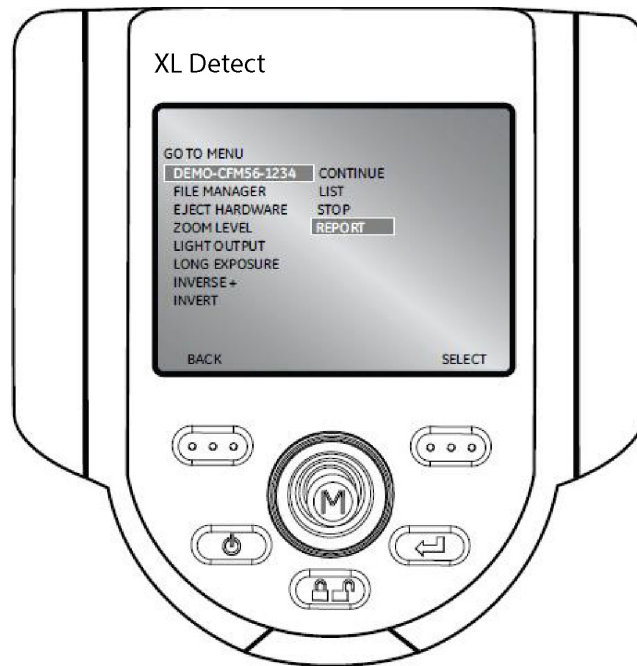

Benefits to using MDI include:

- Standardized Inspection Lists
- Consistent Report Creation in MS Word format
- Data Management
- Decreased reporting time by up to 70%
- Increased speed and ease of sharing data
- Reduction of errors with guided inspections

# 6 Maintenance

## Inspecting and Cleaning the System

Inspect and clean the XL Detect system before and after each use with a soft cloth and a 70% alcohol-to-water solution. If using the system in a dirty environment, clean the components more frequently, as needed.

If damage is found, contact Waygate Technologies for return instructions and an RMA (return material authorization) number. Early detection of minor conditions can prevent costly repair.

## Cleaning Optical Tips

Dirty optical tip surfaces cause distorted or blurred images. For best image quality, clean the optical tip and camera head frequently.

To clean the probe tip, including the lens on the camera head, use glass cleaner or 70% alcohol-to-water solution and a pointed cotton swab. Three surfaces need cleaning: the head can optics, the outside of the tip, and the inside of the tip.

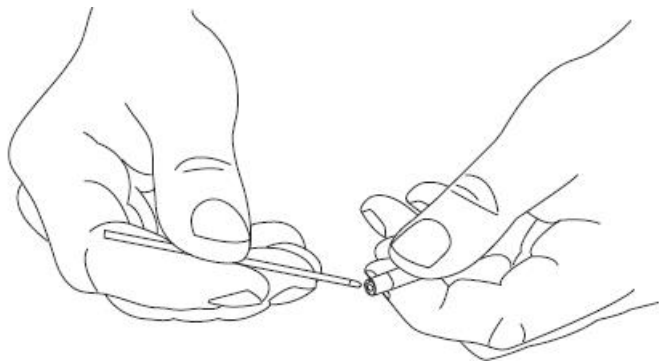

# 7 Service

To obtain service for a VideoProbe system, please contact one of the service centers listed. If the problem cannot be corrected over the phone, a Return Materials Authorization number (RMA) will be given along with instructions for shipment to an authorized service center.

Always contact an authorized Waygate Technologies service center for an RMA prior to returning a product for service and/or repair.

Should you have any questions concerning clarification of problems in connection with application, use, operation, specification of your Remote Visual Inspection equipment, please contact the following:

## Technical Support Contact Information

**Global Phone:** 1-866-243-2638

Tech Support Option: 4#

Help as easy as 1- 2- 3 - 4:

- 1 - Ultrasonic / Eddy Current
- 2 - Radiography
- 3 - Remote Visual Inspection
- 4 - Rhythm Software
- 5 - PMI (Positive Material Identification)

Email: [ITTechSupport@GE.com](mailto:ITTechSupport@GE.com)

Website: [ge-mcs.com/contact-us](http://ge-mcs.com/contact-us)

**Contact information is subject to change.** Please visit the Waygate Technologies website for the latest contact information:

<https://www.ge-mcs.com>

# 8 Technical Specifications

## Operating Temperature

Tip	-25°C to 100°C (-13°F to 212°F) Reduced articulation below 0°C (32°F)
System	-20° to 46° C (-4°F to 115°F) LCD requires warm-up period below 0°C (32°F)
Storage Temperature	-25° to 60° C (-13°F to 140°F)
Relative Humidity	95% max, non-condensing
Waterproof	Insertion tube and tip to 14.7 psi (1 bar, 10.2m of H2O, 33.5 ft of H2O)
Hazardous Environments	Not rated for use in hazardous environments.

## Camera

Diameter Probe	6.1 mm (0.24") 8.4 mm (0.33")
Image Sensor	1/6" Color SUPER HAD™ CCD camera
Pixel Count	440,000 pixels
Housing	Titanium
Diameter Probe	4.0 mm (0.16")
Image Sensor	1/10" Color SUPER HAD™ CCD camera
Pixel Count	290,000 pixels
Housing	Titanium

## System

### System Dimensions

XL Detect	9.5 x 13.3 x 34.3 cm (3.8 x 5.3 x 13.5")
XL Detect+	10.2 x 16.5 x 34.3 cm (4.0 x 6.5 x 13.5")
Case Dimensions	48.8 x 38.6 x 18.5 cm (19.2 x 15.2 x 17.3")
System Weight	XL Detect In Case - 6.5 kg (14.3 lbs) XL Detect Out of Case - 1.7 kg (3.8 lbs) XL Detect+ In Case - 6.5kg (14.3) XL Detect+ Out of Case - 1.98 kg (4.37 lbs)

Construction	Polycarbonate housing with integrated Versalon™ bumpers
LCD Monitor	XL Detect: Integrated 9.4 cm (3.7") active matrix VGA color LCD. Transflective, sunlight readable display.  XL Detect+: Integrated 12.7 cm (5.0") active matrix VGA color LCD, Transmissive display.
Joystick Control	360° All-Way® tip articulation, menu access, and navigation
Button Set	Access user functions, measurement, and digital functions
Audio	Integrated 2.5mm headset / microphone jack
Internal Memory	XL Detect: 1GB flash memory XL Detect+: 4GB flash memory
Data I/O ports	1 USB 2.0 port VGA Video Out
Brightness Control	Auto and Variable
Illumination Type	White LED
Long Exposure	Auto - up to 16 seconds Manual - up to 2.5 seconds
White Balance	Factory default or user defined
<b>Power</b>	
Lithium Ion Battery	8.4 V 38 Wh (2-hour) or 75 Wh (4-hour)
<b>Power Supply</b>	
XL Detect	AC Input: 90-264 Vac, 47-63Hz, <1.2Arms @ 90 Vac DC Output: 10.2V +5/-3%. 4.9A

## **XL Detect Standards Compliance and Classifications**

### ***NOTE: XL Detect+ Available upon request***

Standards Compliance	Tested to EMC: EN61326-1 (Basic radiated immunity) Group 1 Class A SAFETY: UL/IEC/EN 61010-1, CSA C22.2:61010-1 BATTERY: UN/DOT T1-T8, EN 62133 POWER SUPPLY: UL/IEC/EN 60950-1
IP Rating	XL Detect: Tested to IP55 XL Detect+: Tested to IP65

## Software

Operating System	Real-time, multi-tasking operating system
User Interface	Simple drop-down, menu-driven operation, menu navigation using articulation joystick
File Manager	Embedded file manager software supporting: file and folder creation, naming, deleting, storing to internal flash or USB ThumbDrive®, copying between USB and internal flash
Audio Data	PC compatible (.aac) file format
Image Control	Zoom (5x digital), Image Capture and Recall
Digital Zoom	Continuous (5x)
Image Formats	Bitmap (.BMP), JPEG (.JPG)
Video Format	MPEG4 (.MP4)
Text Annotation	Built-in full-screen text overlay generator
Graphic Annotation	User placement of arrows
Articulation Control	Steer & Stay Articulation lock/fine articulation, tip “Home” return to neutral forward-tip orientation User-selectable fine or coarse control
Software Updates	Field upgradable via USB ThumbDrive®
Languages	English, Spanish, French, German, Italian, Russian, Japanese, Korean, Portuguese, Chinese, and Polish
Application Software	Menu Directed Inspection (MDI) software digitally guides inspectors through the inspection process, intelligently names files and creates MS Word compatible inspection reports.

®



## Probe Measurements

### Diameter

4.0 mm (0.15")

6.1 mm (0.24")

8.4 mm (0.33")

### Length

2.0, 3.0 m (6.6, 9.8 ft.)

2.0, 3.0, 4.5, 6.0 m  
(6.6, 9.8, 14.8, 19.7 ft.)

3.0, 10.0 m  
(9.8, 32.8 ft.)

## Tip Articulation

### Insertion Tube Length

2.0, 3.0, 4.5m

6.0 m

10. m

### Straight Line

Up/Down 140° min  
Left/Right 140° min















Up/Down 120° min  
Left/Right 120° min

Up/Down 100° min  
Left/Right 100° min

**Note:** Typical articulation exceeds minimum specifications.

# 8 Appendix

## A- Optical Tip Table

Tip	Diameter (mm)	View (DOV)	Color	Field of View (FOV)	Depth of Field (DOF)	Part Number
<b>Standard Optical Tips</b>						
	4.0	Forward	None	80	6-80mm .24-3.15"	T4080FF
	4.0	Side	Brown	80	4-80mm .16-3.15"	T40120SF
	4.0	Forward	Orange	90	3-40mm .12-1.57"	T40115FN
	4.0	Side	Red	90	2-16mm .08-.63"	T40115SN
	6.1	Forward	None	50	50mm-infinity 1.97" - infinity	XLG3T6150FF
	6.1	Forward	White	50	12-200mm .47-7.87"	XLG3T6150FG
	6.1	Forward	Black	120	5-120mm .20-4.72"	XLG3T61120FG
	6.1	Forward	Orange	80	3-20mm .12-.79"	XLG3T6180FN
	6.1	Forward	Yellow	90	20mm-infinity .79"-infinity	XLG3T6190FF
	6.1	Forward Oblique	Purple	50	12-80mm .5-3.2"	XLG3T6150FB
	6.1	Side	Brown	50	45mm-infinity 1.77"-infinity	XLG3T6150SF
	6.1	Side	Green	50	9-160mm .35-6.30"	XLG3T6150SG
	6.1	Side	Blue	120	4-100mm .16-3.94"	XLG3T61120SG
	8.4	Forward	None	40	250mm-infinity 9.84"-infinity	XLG3T8440FF

Tip	Diameter (mm)	View (DOV)	Color	Field of View (FOV)	Depth of Field (DOF)	Part Number
-----	---------------	------------	-------	---------------------	----------------------	-------------

**Standard Optical Tips**

	8.4	Forward	White	40	80mm-500mm 3.15-19.69	XLG3T8440FG
	8.4	Forward	Black	120	5-200mm 0.20-7.87	XLG3T84120FN
	8.4	Forward	Gold	20	500mm-infinity 19.69"-infinity	XLG3T8420FF
	8.4	Forward	Yellow	80	25-500mm .98-19.69"	XLG3T8480FG
	8.4	Side	Brown	40	250mm-infinity 9.84"-infinity	XLG3T8440SF
	8.4	Side	Green	80	25-500mm .98-19.69"	XLG3T8480SG
	8.4	Side	Blue	120	5-200m .16-7.87"	XLG3T84120SN

## B. Chemical Compatibility

Chemical compatibility refers to the probe's ability to come into contact with various liquid substances and not be damaged.



**WARNING:** Do not use this system in explosive environments.

These substances are safe for a short duration of contact with the insertion tube:

- Water
- Aircraft Gasoline
- Jet-A-Fuel
- Isopropyl alcohol
- JP-4 Fuel
- Kerosene
- Synthetic Turbo Oil
- Gasoline
- Diesel Fuel
- Hydraulic Oil
- Inhibited Transformer Oil

Subsequent to contact with the above fluids, the insertion tube must be cleaned prior to storage.

## C. Warranty

Waygate Technologies warrants its VideoProbe components, when new, to be free from defects in material and workmanship and to perform in accordance with manufacturer's specifications under normal use and service for a period of one year from the date of purchase from Waygate Technologies or its authorized distributors, except that, the light source is warranted for a period of 3 years from the date of purchase, the battery is warranted for a period of 30 days from the date of purchase, and where used, servo motors in the articulation drive system are warranted for the life of this VideoProbe product.

Waygate Technologies' obligation under this warranty is limited to the repair or replacement of components determined by Waygate Technologies to be defective within the warranty period at no cost to the original purchaser, except for return shipping expenses. It shall be the purchaser's responsibility to return the product to Waygate Technologies or one of its authorized service centers. The warranty does not cover accessories or optional equipment not manufactured by Waygate Technologies, but these items may be covered by separate manufacturers' warranties.

This warranty extends to the original purchaser and cannot be assigned or transferred to any third party. This warranty shall not apply to any damage or product failure determined by Waygate Technologies to have been caused by misuse, accident (including shipping damage), neglect, improper maintenance, modification or repair by someone other than Waygate Technologies or one of its authorized service representatives.

These express warranties are in lieu of any other warranties, express or implied, including the warranties of merchantability and fitness for a particular purpose, and no other person has been authorized to assume for Waygate Technologies any other liability in connection with the sale of its VideoProbe products. Waygate Technologies shall not be liable for any loss or damages, whether direct or indirect, incidental, or consequential, resulting from the breach of any express warranty set forth herein.

## **D. Creating a Personalized Logo File**

The XL Detect allows users to display a personalized logo on-screen or store with captured images. Typically, this file will be a corporate logo.

### **LOGO File Requirements**

- 200 x 200 pixels maximum size
- 24 Color
- File name must be logo.jpg
- File must be Microsoft® Windows® compatible

### **Creating the Logo File**

1. Open logo file with image editor.
2. Create custom background comprised of Red 255, Green 0, Blue 255.  
This will create a magenta-colored background that will appear transparent when loaded on the XL Detect.
3. Save this file as a .png.
4. Close image editor.
5. Locate the saved file, right click, choose rename. Rename file from logo.png to logo.jpg.  
This will allow it to be recognized by the XL Detect.
6. Transfer file to the USB ThumbDrive provided with system.
7. Insert ThumbDrive into USB port on the XL Detect.
8. Press joystick to enter Live Main Menu
9. Navigate to SETUP > SCREEN/DISPLAY > LOGO
10. Select LOAD
11. Prompt will display “LOGO COPY COMPLETE”

# 9 Environmental Compliance

## EU Battery Directive



This product contains a battery that cannot be disposed of as unsorted municipal waste in the European Union. See the product documentation for specific battery information. The battery is marked with this symbol, which may include lettering to indicate cadmium (Cd), lead (Pb), or mercury (Hg). For proper recycling return the battery to your supplier or to a designated collection point.

### What do the markings mean?

Batteries and accumulators must be marked (either on the battery or accumulator or on its packaging, depending on size) with the separate collection symbol. In addition, the marking must include the chemical symbols of specific levels of toxic metals as follows:

Cadmium (Cd) over 0.002%

Lead (Pb) over 0.004%

Mercury (Hg) over 0.0005%

### The risks and your role in reducing them

Your participation is an important part of the effort to minimize the impact of batteries and accumulators on the environment and on human health. For proper recycling you can return this product or the batteries or accumulators it contains to your supplier or to a designated collection point. Some batteries or accumulators contain toxic metals that pose serious risks to human health and to the environment. When required, the product marking includes chemical symbols that indicate the presence toxic metals: Pb for lead, Hg for mercury, and Cd for cadmium. Cadmium poisoning can result in cancer of the lungs and prostate gland. Chronic effects include kidney damage, pulmonary emphysema, and bone diseases such as osteomalacia and osteoporosis. Cadmium may also cause anemia, discoloration of the teeth, and loss of smell (anosmia). Lead is poisonous in all forms. It accumulates in the body, so each exposure is significant. Ingestion and inhalation of lead can cause severe damage to human health. Risks include brain damage, convulsions, malnutrition, and sterility. Mercury creates hazardous vapors at room temperature. Exposure to high concentrations of mercury vapor can cause a variety of severe symptoms. Risks include chronic inflammation of mouth and gums, personality change, nervousness, fever, and rashes.

Visit [http://ec.europa.eu/environment/waste/weee/index\\_en.htm](http://ec.europa.eu/environment/waste/weee/index_en.htm) for take-back instructions and more information about this initiative.

## Agency Certifications

### European Equipment Classification

Group 1, Class A

The **CE** mark on this product indicates it has been tested to and conforms with the provisions noted within the 2014/30/EU Electromagnetic Compatibility Directive. The XL Detect+ system is in conformance with the following standard: EN61326-1.

**Safety Mark**

The XL Detect system is in compliance with the following standards:  
UL 61010-1, IEC 61010-1, EN 61010-1 and CSA-C22.2 No. 61010-1.

**Additional Certification Testing**

UN / DOT T1-T8

Declarations of Conformity are held by Baker Hughes Digital Solutions GmbH:

7Robert Bosch Str. 3  
50354 Huerth  
Germany  
Tel: +49 2233 601 111 Ext. 1  
E-mail: GEITHuerth.Service@ge.com

**Safety Mark**



The XL Detect system is in compliance with the following standards:  
UL 61010-1, IEC 61010-1, EN 61010-1 and CSA-C22.2 No. 61010-1.

**Additional Certification Testing**

UN / DOT T1-T8

# China RoHS

Per Article 14 of The Management Methods for Restricted Use of Hazardous Substances in Electrical and Electronic Products-Order No. 32 (“China RoHS 2”), electronic products are to be marked to indicate the presence of hazardous substances within those products. In addition, that mark is to indicate the term of environmentally-friendly use before the product should be disposed or recycled. A copy of this mark for the product appears below (NOTE: For products too small to accommodate the mark on their surface, the mark below is the ONLY mark for the product).

Inspection Device	EFUP Marking (Years)
Probe (UT, EM)	
Instrument	

Per Article 13 of The Management Methods for Restricted Use of Hazardous Substances in Electrical and Electronic Products-Order No. 32 (“China RoHS 2”), electronic products are to be marked to indicate the substances including the name of the substance(s) and the component(s) containing those substances. The following table provides that information:

产品中有害物质的名称及含量

部件名称 Component Name	有害物质 Hazardous Substances' Name					
	铅 (Pb)	汞 (Hg)	镉 (Cd)	六价铬 (Cr(VI))	多溴联苯 (PBB)	多溴二苯醚 (PBDE)
Printed Circuit Boards (PCB板)	X	O	O	O	O	O
Cables and connectors 线缆及连接器	X	O	X	O	O	O
Metals 金属件	X	O	O	O	O	O
Plastics, paints, ceramics 塑料件, 喷涂件, 陶瓷件	X	O	O	O	O	O
Fluids 工业用液 (绝缘油, 润滑油, 耦合剂, 清洗剂, 冷媒等)	O	O	O	O	O	O
Batteries 电池	X	O	O	O	O	O
Screen, Keypad, other controls 屏幕, 按键及其他控制部分	X	O	O	O	O	O
Electrical Circuits (not Printed Circuit Boards) PCB以外的电气回路部分	X	O	O	O	O	O

本表格按照SJ/T 11364的标准编制。  
This table is prepared according to SJ/T 11364.  
O: 表示该有害物质在该部件所有均质材料中的含量均在GB/T 26572规定的限量要求以下。  
X: 表示该有害物质至少在该部件的某一均质材料中的含量超出GB/T 26572规定的限量要求。  
(企业可在此处, 根据实际情况对上表中打“X”的技术原因进行进一步说明。)  
O: indicates hazardous substance concentration less than or equal to MCV  
X: indicates hazardous substance concentration higher than MCV  
(company can explain technical reason to mark 'X')



It accumulates in the body, so each exposure is significant. Ingestion and inhalation of lead can cause severe damage to human health. Risks include brain damage, convulsions, malnutrition, and sterility. Mercury creates hazardous vapors at room temperature. Exposure to high concentrations of mercury vapor can cause a variety of severe symptoms. Risks include chronic inflammation of mouth and gums, personality change, nervousness, fever, and rashes.

## **FCC Compliance**

This device complies with part 15 of the FCC Rules. Operation is subject to the following two conditions:

- 1) This device may not cause harmful interference
- 2) this device must accept any interference received, including interference that may cause undesired operation.

This equipment has been tested and found to comply with the limits for a Class A digital device, pursuant to part 15 of the FCC Rules. These limits are designed to provide reasonable protection against harmful interference when the equipment is operated in a commercial environment. This equipment generates, uses, and can radiate radio frequency energy and, if not installed and used in accordance with the instruction manual, may cause harmful interference to radio communications. Operation of this equipment in a residential area is likely to cause harmful interference in which case the user will be required to correct the interference at his own expense.

## **Canadian Notice**

This equipment does not exceed the Class A limits for radio noise emissions as described in the Radio Interference Regulations of the Canadian Department of Communications.

Le present appareil numerique n'emet pas de bruits radioelectriques depassant les limites applicables aux appareils numeriques de la classe A prescrites dans le Reglement sur le brouillage radioelectrique edicte par le ministere des Communications du Canada.

# 10 Disassembly and Disposal



The equipment purchased has required the extraction and use of natural resources for its production. It may contain hazardous substances that could impact health and the environment.

In order to avoid the dissemination of those substances in the environment and to diminish the pressure on the natural resources, we encourage the use of appropriate take-back systems. Those systems will reuse or recycle most of the materials of end-life equipment in a sound way.

The cross-out wheeled bin symbol encourages the use of those systems.

If more information is needed on the collection, reuse, and recycling systems, please contact your local or regional waste administration. The waste administration has the necessary documentation on how to disassemble and recycle accordingly.

For further details, please contact Technical Support.

## Customer Support Centers

### USA

Waygate Technologies, LP  
721 Visions Drive  
Skaneateles, NY 13152  
Tel: 888-332-3848  
315-554-2000 ext. 1  
E-mail: RemoteService@  
BakerHughes.com

### Europe

Baker Hughes Digital Solutions  
GmbH  
7Robert Bosch Str. 3  
50354 Huerth  
Germany  
Tel: +49 2233 601 111 Ext. 1  
E-mail: GEITHuerth.Service@ge.com

### Asia/Pacific

Baker Hughes Solutions Pte. Ltd.  
10 Lok Yang Way  
Singapore 628631  
Phone: +65 62135500  
E-mail: Asia.ServiceIT@ge.com

### China

Baker Hughes Sensing & Inspection  
Co., Ltd.  
No. 8 Xi hu Road, Wu jin high-tech  
zone  
Changzhou, Jiang Su 213164  
China  
Tel: + 86 400 818 1099  
E-mail: Service.mcchina@ge.com

### Russia

Baker Hughes Rus Infra LLC  
Industrial Park "Rosva"  
Rosva Kaluga, 248001, Russia  
Phone: +7 4842 716 576  
E-mail: GEITKaluga.service@ge.com

[waygate-tech.com](http://waygate-tech.com)

Assembled in USA

**ISO 9001**

REGISTERED COMPANY

©2020 Baker Hughes

All rights reserved. Specifications subject to change without notice.

Printed in USA